



Deviation User Manual for Devo 6/8/12

Release 5.1-dev

<http://www.deviationtx.com>

May 06, 2020

1	Overview	1
1.1	Disclaimer	2
1.2	Notices	2
1.3	Legal status and copyright	2
2	Installation	3
2.1	Preparation	3
2.1.1	Windows Driver Installation	4
2.2	DFU Installation With Walkera DfuSe	4
2.3	Upgrading the file system via USB	6
2.4	DFU Installation with Deviation Uploader	6
2.5	Upgrading the file system with Deviation Uploader	7
2.6	Deviation 5.0	7
2.7	Nightly Deviation Builds	7
2.8	Test Builds	8
2.9	USB & File-system	8
3	Reporting Bugs	11
4	A Note About this Manual	13
5	Main Page	15
5.1	Safety System	17
6	Navigating	19
6.1	Navigating with the physical buttons	20
6.2	Menu Layout	20
7	Transmitter Menu	21
7.1	Transmitter config	21
7.1.1	Generic settings	22
7.1.2	Buzzer settings	23
7.1.3	LCD settings	23

7.1.4	Timer settings	23
7.1.5	Telemetry settings	24
7.2	Channel monitor	24
7.3	Input Monitor	25
7.4	Button Monitor	26
7.5	Telemetry monitor	27
7.6	Range Test	28
7.7	USB/About	29
8	Model menu	31
8.1	Model setup (Std & Adv GUI)	32
8.1.1	Predefined Model Templates	37
8.2	Mixer (Adv GUI)	38
8.2.1	Channel Reorder	39
8.2.2	Channel configuration	39
8.2.3	Virtual channel configuration	41
8.2.4	Simple Mix Type	41
8.2.5	Expo & Dual-Rate Mix Type	42
8.2.6	Complex Mix Type	43
8.2.7	Cyclic	44
8.2.8	Reordering Mixers	45
8.2.9	Available Curves	45
8.2.10	Curve Editing	46
8.3	Timers (Std & Adv GUI)	48
8.4	Telemetry config (Std & Adv GUI)	50
8.5	Trims and Virtual Inputs (Std & Adv GUI)	51
8.6	Datalog (Std & Adv GUI)	52
8.7	Main page config (Std & Adv GUI)	53
8.7.1	Configuring object position	53
8.7.2	Creating Objects	54
8.7.3	Loading Objects	54
8.7.4	Configuring Objects	55
8.7.5	Choosing toggle icons	56
8.8	Standard GUI Menu items	56
8.8.1	Servo Reverse	58
8.8.2	Dual-Rate/Expo setting	58
8.8.3	Sub-trim Adjustment	59
8.8.4	Servo Travel Adjust	60
8.8.5	Swash Configuration	60
8.8.6	Throttle Curve	61
8.8.7	Pitch Curve	62
8.8.8	Gyro Sensitivity	62
8.8.9	Switch Assignment	63
8.8.10	Throttle Hold	63
8.8.11	Fail-Safe Configuration	64
9	Protocols	65
9.1	Protocol: DEVO	65

9.2	Protocol: WK2801	66
9.3	Protocol: WK2601	66
9.4	Protocol: WK2401	67
9.5	Protocol: DSM2	67
9.6	Protocol: DSMX	69
9.7	Protocol: J6Pro	69
9.8	Protocol: WFLY	69
9.9	Protocol: *Flysky	69
9.10	Protocol: *AFHDS-2A	70
9.11	Protocol: *Hubsan4	71
9.12	Protocol: *Joysway	72
9.13	Protocol: *Bugs3	72
9.14	Protocol: *Frsky-V8	73
9.15	Protocol: *Frsky	73
9.16	Protocol: *FrskyX	73
9.17	<i>Frsky and FrskyX Extended Telemetry</i>	74
9.18	Protocol: *Skyartec	75
9.19	Protocol: *Futaba S-FHSS	76
9.20	Protocol: *Corona	76
9.21	Protocol: *Hitec	76
9.22	Protocol: *V202	77
9.23	Protocol: *SLT	77
9.24	Protocol: *HiSky	78
9.25	Protocol: *YD717	78
9.26	Protocol: *SymaX	78
9.27	Protocol: *Hontai	79
9.28	Protocol: *Bayang	79
9.29	Protocol: *FY326	80
9.30	Protocol: *CFlie	81
9.31	Protocol: *H377	81
9.32	Protocol: *HM830	81
9.33	Protocol: *KN	81
9.34	Protocol: *ESky150	82
9.35	Protocol: *Esky	82
9.36	Protocol: *BlueFly	82
9.37	Protocol: *CX10	83
9.38	Protocol: *CG023	83
9.39	Protocol: *H8_3D	83
9.40	Protocol: *MJXq	84
9.41	Protocol: *Bugs3Mini	84
9.42	Protocol: *E012	85
9.43	Protocol: *E015	85
9.44	Protocol: *NCC1701	86
9.45	Protocol: *V911S	86
9.46	Protocol: *GD00X	86
9.47	Protocol: *LOLI	87
9.48	Protocol: *E016H	87
9.49	Protocol: PPM	87

9.50	Protocol: USBHID	88
9.51	Protocol: SBUS	88
9.52	Protocol: CRSF (Crossfire)	89
9.53	Protocol: PXX	89
10	Advanced Topics	93
10.1	Setting up a Buddy-Box	93
10.1.1	Master Mode	93
10.1.2	Slave Mode	95
10.2	Setting Up FPV or Other External Inputs	95
10.3	Using a Trim as a Virtual Switch	95
10.4	Swash Mixing	97
10.5	Modifying sounds	99
11	Emulator	101

CHAPTER 1

Overview

Deviation is a replacement firmware for the Walkera Devention™ series (Devo) transmitters. The primary goal is to add support for multiple protocols, opening the full potential of this platform. The core of the deviation firmware is the mixer system, which is modeled after the system used in the Er9X firmware for the Turnigy/Flysky9x™ transmitters.

Deviation also brings USB file-system support, making it easy to manage the transmitter from any PC without the need for specialized upload/download tools.

Deviation has been designed for ultimate configurability. All model and transmitter configuration is controlled through text files which the firmware (or user) can read and write. It is easy to know exactly what is configured, as well as to modify the configuration either through the transmitter or with a text editor. The main screen is very customizable; any mix of inputs, switches, channel data, or timers can be displayed, and configured per-model.

Deviation supports multiple protocols without any modifications to the transmitter:

- Walkera Devo 6/7/8/10/12
- Walkera WK2401 / WK2601 / WK2801
- DSM2 / DSMX
- Nine Eagles J6 Pro (requires telemetry module)

Deviation can support many other protocols with very easy transmitter modifications (appropriate transceiver module needed). Among the more popular are:

- Flysky (also for WLToys V911, V9x9, and Xieda 9938)
- Hubsan-X4 and Estes Proto X
- V202
- SLT

- FrSky

Deviation supports (flight) simulators connected via DSC cable (PPM) or USB cable (USBHID). Deviation also allows Buddy-Box and FPV setups.

Deviation can store up to 255 different models, and uses a portable syntax that allows sharing models between any transmitter supported by Deviation.

Deviation has been internationalized and comes with translations for English, Afrikaans, Traditional Chinese, Dutch, Spanish, French, German, Hungarian, Italian, Romanian, Russian and Chinese. New languages can be added by installing the proper translation file.

1.1 Disclaimer

Deviation is experimental software. There are no guarantees made or implied about the quality or reliability of this software. RC models can cause serious injury or even death if flown improperly. By deciding to use the Deviation software, you are taking sole responsibility for the control of your models. The authors of Deviation will not be held responsible for any injury or damage whatsoever caused by the use of the Deviation firmware. Be careful and cautious.

1.2 Notices

Deviation is an independent work. The Deviation project is not affiliated, supported or acknowledged by Walkera®. The authors have never been in contact with Walkera nor do they know of Walkera's stance on this project. The Deviation team provides no guarantee that the Deviation firmware will not harm your transmitter (although this should not be possible). There is also no guarantee that Walkera® will not make changes to future versions of the hardware, firmware of Dfuse tool which would make it incompatible with Deviation.

1.3 Legal status and copyright

This project is free software: you can redistribute it and/or modify it under the terms of the GNU General Public License as published by the Free Software Foundation, either version 3 of the License, or (at your option) any later version. You should have received a copy of the GNU General Public License along with Deviation. If not, see www.gnu.org/licenses.

Deviation is distributed in the hope that it will be useful, but WITHOUT ANY WARRANTY; without even the implied warranty of MERCHANTABILITY or FITNESS FOR A PARTICULAR PURPOSE. See the GNU General Public License for more details.

The Deviation Project is hosted at www.deviationtx.com and the Source are available at <https://github.com/DeviationTX/deviation>.

Windows™ users can choose between two methods of installing the deviation firmware.

- 1) Use the Deviation Uploader tool
- 2) Use the Walkera DfuSe USB Upgrade tool (Windows™ only)

If you do not have the Windows™ operating system, go with the first choice, the Deviation Uploader tool. It is a Java application that was designed by the Deviation developer team to be efficient and simple to use with any Devo radio and any version of deviation or even Devention, if you should wish to revert to the original Walkera firmware. The Walkera tool uses a two-step approach, in which you first install the firmware, then the filesystem library. The Deviation Uploader tool does the same thing in one simple, convenient step, using the ZIP compressed deviation firmware file as the source.

The *Preparation* section covers things you need to do before starting an installation. Then, two installation sections cover the actual installation, depending on which tool you are using. There are sections following that include notes specific to upgrading from or to various versions and build types.

2.1 Preparation

First, ensure that your Devo is fully charged before starting the installation. Download the deviation-devoXX-x.y.z.zip firmware from <http://deviationtx.com/downloads-new/category/1-deviation-releases> where XX is the number of your Walkera Devo™ transmitter. x.y.z identifies the deviation version number.

NOTE: Do NOT attempt to use the DfuSe tool from STMicroelectronics!

You can download the Walkera tool from: https://drive.google.com/drive/u/0/folders/0B6SupsT8-3_BYXNQM1dOUIRYcGM

The Deviation Uploader tool can be downloaded from <http://deviationtx.com/downloads-new/category/161-dfu-usb-tool>

If you are using Windows™, you need to install the appropriate USB drivers. See the section on *Windows Driver Installation*

Unzip the tools and install them locally. If you are using the Deviation Uploader tool, it is not necessary to unzip the firmware you downloaded. It is recommended that you test the DFU tool by first upgrading your TX to a different version of Walkera firmware.

If you are upgrading from a previous Deviation release, it is strongly recommended that you back-up the 'models' directory from the transmitter as well as the 'tx.ini' and the 'hardware.ini' files to ensure you don't lose any model or transmitter configuration.

2.1.1 Windows Driver Installation

The Walkera DfuSe tool and the Deviation Uploader tool use different drivers. Both can be installed by the Deviation USBDrv Installer, available from <http://www.deviationtx.com/downloads-new/category/161-dfu-usb-tool>

Extract the Deviation USBDrv Installer, and run 'DFU USBDrv Installer-x.y.exe'. You can then uninstall both drivers, or install either the Deviation USB Driver for use with the Deviation Uploader or the Walkera driver. Install the driver for the Dfu tool you plan on using.

2.2 DFU Installation With Walkera DfuSe

Installation of Deviation with the Walkera DfuSe tool is done in exactly the same manner as upgrading the Walkera Deviation firmware. Note that Deviation will NOT overwrite Walkera models stored on the transmitter. While they cannot be accessed by Deviation, they will be safely preserved should the Walkera firmware ever need to be reinstalled

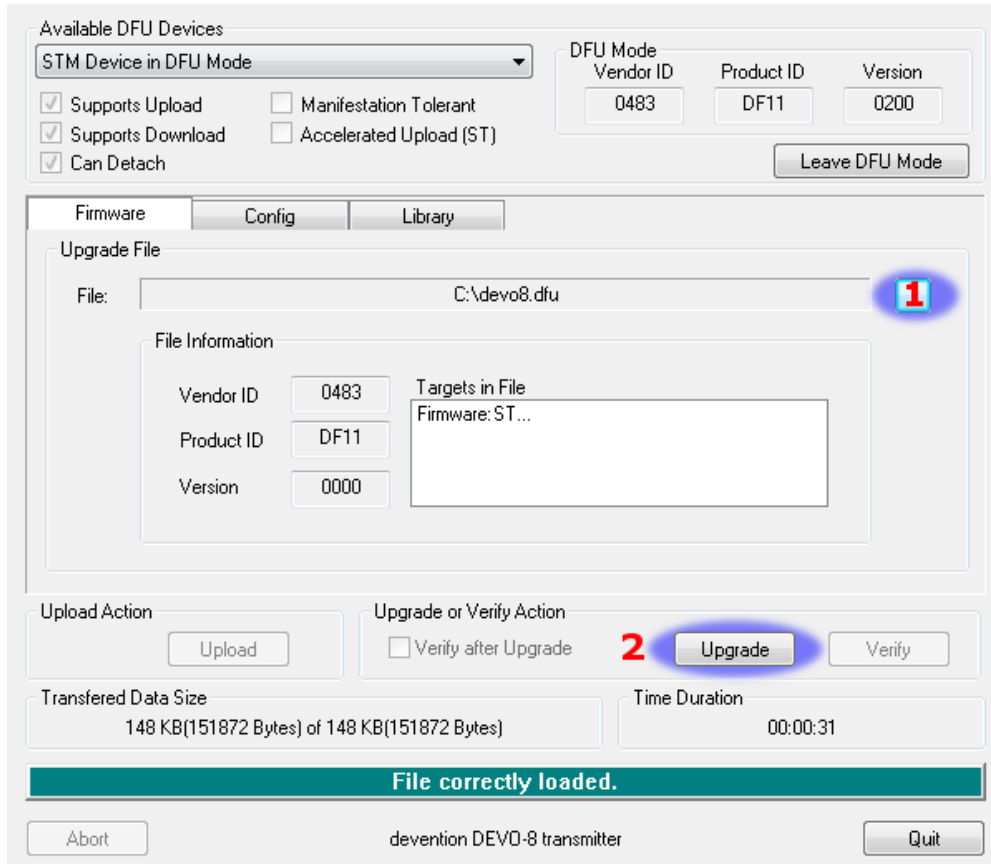

Unzip the firmware file that you downloaded earlier. Plug the transmitter into the PC via USB, and turn on the transmitter while holding ‘EXT’ to enter programming mode. On the Devo12, this is done by holding the trainer switch instead.

Several users have reported compatibility issues with Windows™ and/or USB ports when running this tool. If DfuSe does not recognize your TX, try removing all USB devices and restart your PC with only the USB connection to the TX. Take the steps necessary to resolve any connection issues.

If your transmitter has been connected correctly ‘STM Device in DFU Mode’ will be displayed under ‘Available DFU Devices’. Otherwise this field will remain blank.

- 1) Press the ‘...’ button and select the deviation-devoXX-vx.y.z.dfu file to install.
- 2) Select ‘**Upgrade**’ to install the firmware. This will be grayed-out if your transmitter is not detected. **Do NOT use ‘Upload’ as this will destroy the dfu file on your PC.**
- 3) **Devo12 Only:** Select the ‘Library’ tab, click ‘...’ select the devo12-lib.dfu from the zip file. Then select ‘**Upgrade**’ again to install the library.

Turn off the transmitter, and turn back on while holding ‘ENT’. There should be a USB logo on the screen. If this is a first-time install of Deviation, the PC should prompt to format a drive. Format using default options. Next, upgrade the file system via USB.

2.3 Upgrading the file system via USB

Open the folder that has been extracted from the zip file and copy all the files and directories inside this folder to the root of the transmitter USB drive. For details of the file-system please see *USB & File-system*. The files with the extension ‘zip’, and ‘dfu’ need not to be copied.

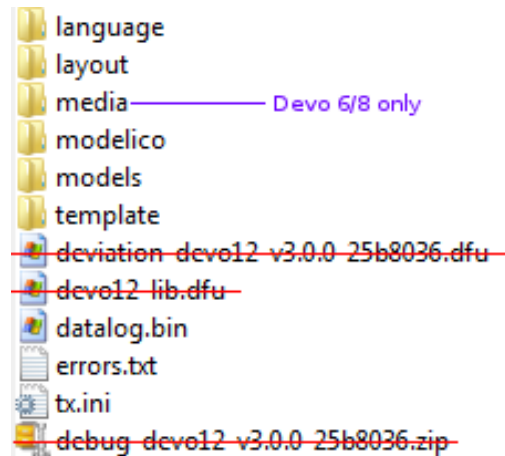

If you are upgrading from an older release, don’t upgrade the ‘tx.ini’, and ‘hardware.ini’ files or the ‘models’ directory. Optionally, copy the ‘models’ directory to the transmitter except for the currently configured model files. This last step will ensure that the defaults for newly created models have the latest options set. If the ‘tx.ini’ file is overwritten, the stick calibration must be repeated and any settings reset.

2.4 DFU Installation with Deviation Uploader

The ‘Deviation Uploader’ is a Java (jar) file. You can either pass the jar file to the Java executable on the command line, or open the file in the GUI, using the Java application to open it. You will need to install Java from <http://www.java.com/> if you haven’t already installed it.

Once the ‘Deviation Uploader’ is open, connect your transmitter to a USB port, and then turn it on while holding down the ‘EXT’ button. On the Devo 12, this is done by holding the trainer switch instead.

If everything is working properly, you should see the ‘Transmitter’ change to the type of the connected transmitter. If it changes to the wrong transmitter type, stop now and seek help from the forums. If it doesn’t change, check the system information to see if the device is listed at all. If it shows up as an unknown device on Windows, then check your driver installation and try unplugging all other USB devices. Take the steps necessary to resolve any connection issues.

- 1) Press the ‘...’ button and select the zip file for the firmware you will install. There is no need to unpack the zip file since the Deviation Uploader will handle that.
- 2) If this is an initial install, all the ‘Replace’ boxes, along with ‘Format’ will be preselected.
- 3) Click the ‘Install/Upgrade’ option. Installation will take a few minutes, so be patient. A pop-up dialog box will notify you when installation is completed. You are done.
- 4) Turn off your Devo transmitter. When you turn it on again, you’ll be greeted by the Deviation splash screen.

For transmitters other than the F7 and F12E, turn the transmitter back on while holding 'ENT'. There should be a USB logo on the screen. If this is a first-time install of Deviation, your computer may prompt to format a drive. Format using default options.

2.5 Upgrading the file system with Deviation Uploader

If you followed the foregoing instructions for installing the deviation firmware ZIP file for your Devo using the Deviation Uploader tool, your installation is complete and no further installations are necessary. If, on the other hand, you unzipped the file and installed the firmware dfu file alone, then you must continue by installing the library dfu file from the same location. There is no advantage in doing the installation this way, but it can be done.

2.6 Deviation 5.0

The long-awaited firmware update from version 4.0.1 to version 5.0 was accomplished on April 30, 2016 and was announced on the DeviationTx website forum. Deviation version 5.0 is the current version and it includes all patches, bug fixes, improvements and protocols of the previous version. Even so, development continues, so new controllers will be added to the support list as well as new protocols and features, when they become available.

2.7 Nightly Deviation Builds

The Nightly builds are versions of Deviation with additional features beyond the Deviation 5.0 release version. The Nightly builds are provided to allow the Deviation community to fully exercise new features so the community can provide feedback and suggestions for improvement. As a user, you recognize that Deviation is a community supported software system, and members of this community can contribute by verifying, validating or commenting on the features that they've used. Nightly builds are found at <http://www.deviationtx.com/downloads-new/category/13-nightly-builds>

These builds are published when new features are added to the Deviation core feature set, when major bugs are corrected and when new hardware support is added. The nightly builds are tested but not to the rigorous extent of a full release. Please read this post! <http://www.deviationtx.com/forum/5-news-announcements/1416-nightly-builds>

The ONLINE User Manual for Deviation is regularly reviewed and updated to include information about new common features. Additionally, while best efforts are made by the Deviation community to update these User Guides, this documentation MAY NOT fully describe the features of the nightly builds. Any Deviation user with an update or change to the manual can submit additions and changes via the Deviation-manual Github repository's issue tracker at <https://github.com/DeviationTX/deviation-manual/issues> , or edit the source of the manual directly.

So should you load the Deviation 5.0 release or should you load a Nightly? Your own requirements will determine the answer to that question. If you use Walkera, Spectrum and Flysky models, and any number of variations of the WLToys V2x2 quads, the Deviation 5.0 release will be sufficient. If you have one of many

newer small quads, or if you want support for additional hardware beyond additional transmitter modules, you should consider using the Nightly build.

If you are also adding hardware modifications, such as switches or transmitter modules, you should install the Deviation Nightly build first and review the available features. After Deviation is running, install your hardware and modify any settings to support your modifications. This helps you determine the source of issues later for troubleshooting.

2.8 Test Builds

Test Builds are for experienced users only. The Deviation Test builds are prepared by software developers to test new features or hardware options, and require a higher level of experience. These builds may also require specific transmitter configuration or hardware mods.

Some test builds require that you install the latest Nightly prior to installation. **DO NOT INSTALL A TEST BUILD** until you read the thread detailing the reason for that build and how to use it, and know why you would want to use it.

Once you install a test build, **do** add a post to the appropriate thread letting the developer know how things went! That's why they are created - so developers can get feedback, even if it's only a note that things worked fine.

2.9 USB & File-system

Deviation stores all configuration, bitmaps, and models as regular files on the USB file-system. USB can be most easily enabled by holding down the 'ENT' button while powering up the transmitter. Files can then be easily copied to or from the transmitter.

The directory structure is as follows:

\tx.ini	Transmitter configuration. Includes trim settings, calibration data, and the last-used model number
\hardware.ini	Transmitter hardware setup, describing supported hardware modifications. number
\errors.txt	If the firmware crashes or reboots, debug information will be stored in this file
\datalog.bin	File for telemetry data
\media\config.ini	The color scheme and fonts for the transmitter
\media\sound.ini	Contains notes to play for various alarms
\media*.bmp	Images used for the current transmitter theme
\media*.fon	Font files
\models\default.ini	The default model, loaded whenever a model is cleared
\models\model*.ini	Configuration files for each model. Due to a limitation in the firmware, deviation cannot create new files. It is therefore necessary to have a modelxx.ini for each model regardless of whether it is currently in use.
\modelico*.bmp	All available model icons (96x96 pixels is recommended but not required). Model icons must be saved as 16-bit BMP files in either RGB565 (non-transparent) or ARGB1555 (transparent) format.
\templates*.ini	Configuration files used when loading predefined templates. These are nearly identical to the model configuration files, however they do not necessarily define all parameters
\language\lang*.*	Language translation files. These are UTF-8 text files containing the English string and the respective translated string.

Note: Deviation only supports 8.3 style file names. That means file names should be no larger than 'xxxxxxxx.yyy'**

Reporting Bugs

Nobody is perfect.

This firmware has been developed carefully and has been successfully tested by many users around the world. Nevertheless under some circumstances it could happen that the transmitter does not work as you expect. Sometimes this behavior will be a handling problem and sometimes a real bug. Do not hesitate to ask the community at <http://www.deviationtx.com/forum>. Please bear in mind that the firmware can only improved with your help.

If you find a bug in Deviation, please report it here: <https://github.com/DeviationTX/deviation/issues>

You will need to register for an account on the Deviation forums to submit a bug. That account will also allow you to communicate with the Deviation community, and will enable you to get email updates when the bug is updated/fixed.

Please provide as much information as possible in your ticket. Include:

- Build version (you can find this on the 'USB' page of the transmitter)
- Did you compile yourself, or download the dfu?
- Type of transmitter (Devo8, Devo7e, Devo8-emulator, . . .)
- Have you tried reproducing this on the emulator?
- Is this easily reproducible? If so, please provide step-by-step instructions
- What protocol are you using?
- If your transmitter rebooted, please provide the errors.txt on the root file-system of the transmitter along with the 'debug-devo???.zip file that came with the dfu

The more detail you can provide, the faster fixing the issue will be.

CHAPTER 4

A Note About this Manual

The images in this manual will generally show the Devo6/8 interface, though in some cases the Devo12 image will be used instead where it better depicts the capabilities. While the Devo6/8 and Devo12 screens may look a little different in some cases, they will generally have identical behavior. Situations where the Devo6, 8, or 12 behave differently will be noted accordingly.

CHAPTER 5

Main Page

The standard main page layout is as follows:

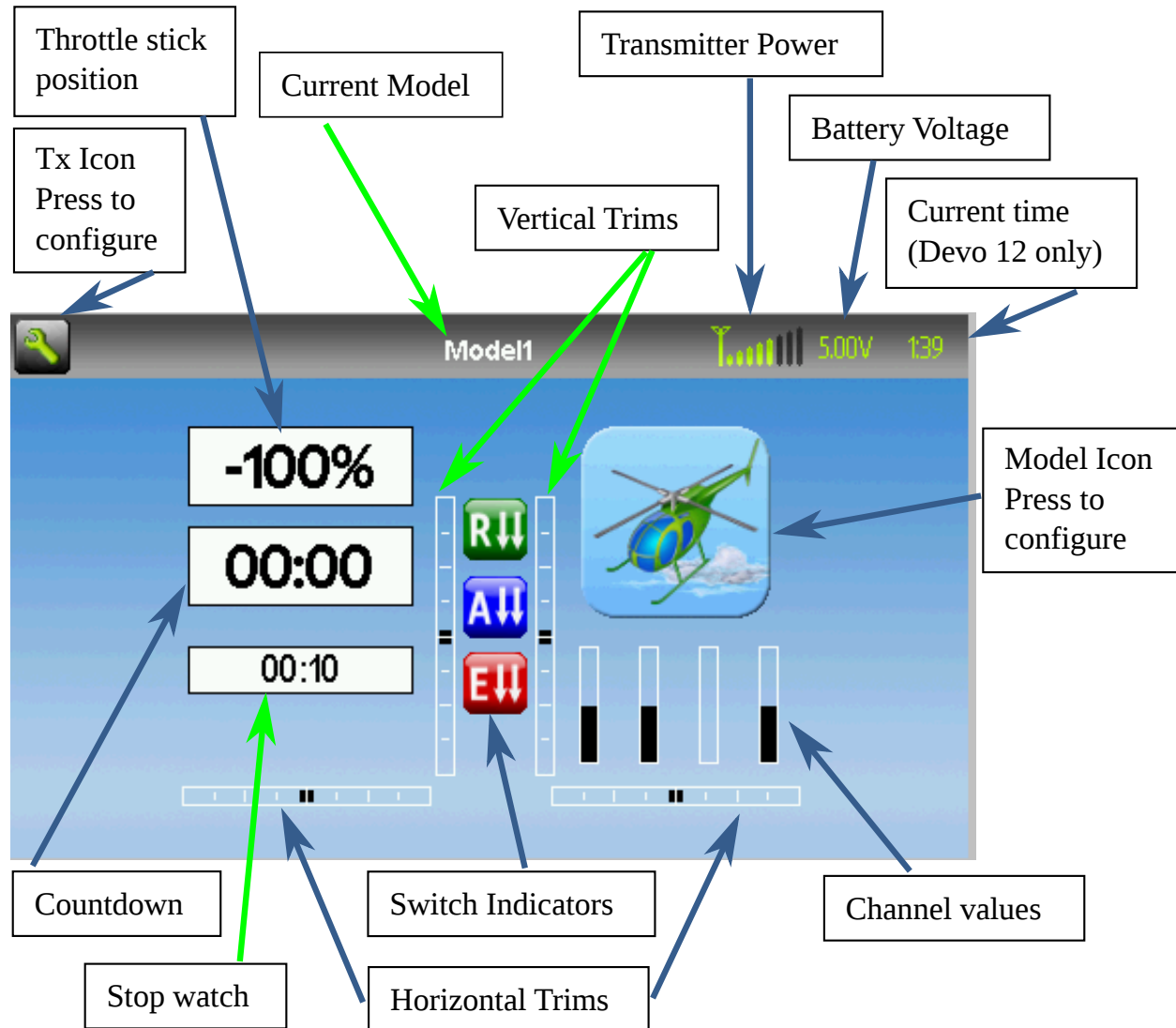

Current Model: The name of the current model. Clicking the label will open up the Model Load page. The model is configured from section *Model setup (Std & Adv GUI)*.

Battery Voltage: Numerical representation of current transmitter battery state.

Transmitter Power: This indicates the currently selected transmitter power. It is configured from section *Model setup (Std & Adv GUI)*.

Current Time: This indicates the current time (on Devo12 transmitters only). The time is set from section *Transmitter config*.

Model Icon: An image representing the current model. It is configured from section *Model setup (Std & Adv GUI)*. Pressing the icon will take you to that page.

Trims: The trim display can be configured to show up to 10 different horizontal and vertical trims.

Displays: These items can be text-boxes containing input, channel, telemetry, or timer data; bar graphs displaying channel data; or icons / toggles displaying specific states (ex. gear, flaps, ...).

Quick Menus: Quick menus can be reached via a long UP/DN press. They can be defined from section

Main page config (Std & Adv GUI).

By default, channel outputs are displayed as $[-100, 100]\%$. This may be tweaked by modifying the following values in the corresponding channel section in *model.ini*:

```
[channel1]
display-scale=100
display-format=%3d%%
```

Before being displayed, outputs have raw values in the range $[-10000, 10000]$. The displayed text is generated via `sprintf(s, display_format, raw/display_scale)`

If *display-scale* is omitted, the default value of *100* will be used.

If *display-format* is omitted, the default value of `%3d%%` will be used. See [Wikipedia](#) for more details on the format string.

5.1 Safety System

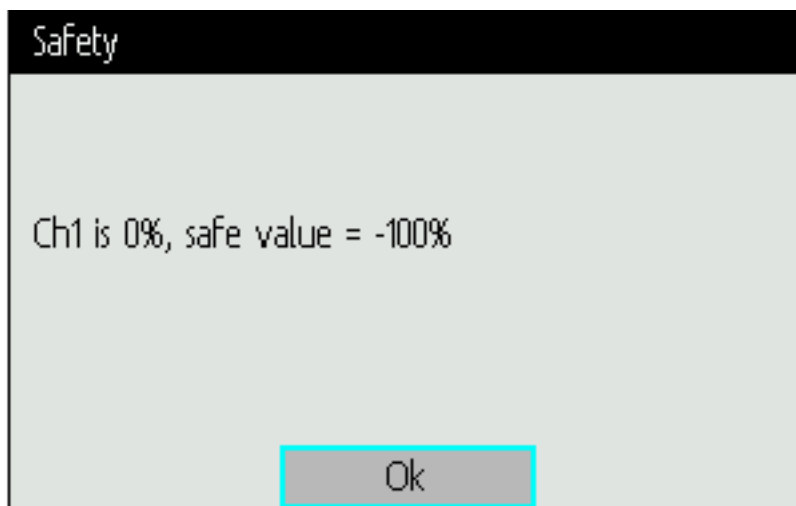

Deviation has a safety system to prevent starting up in a dangerous state (for instance spinning up the main rotor of a helicopter accidentally). The safety system works by verifying that specific conditions are met before starting to transmit to the model. By default the output channel associated with the throttle stick must be minimum. The Deviation firmware does not include a mechanism to define new safety conditions, however, they can be added by directly modifying the *model.ini* file. While the safety message is displayed, the transmitter will not communicate with the model. This message may appear either when initially turning on the transmitter, or when switching to a different model. The message will disappear automatically once all safety conditions have been met or when 'OK' is pressed. In either case, Deviation will start communication with the model once the dialog is dismissed.

The safety values are in the '[safety]' section, and the default looks like this:

```
[safety]
Auto=min
```

The 'Auto' value can also be any channel or input name, 'Ch1', etc. The 'Auto' tries to guess your throttle channel number. If that isn't working, and you're getting an unwanted warning, then changing it to 'Ch1' (DSMx protocols) or 'CH3' (most other protocols) will fix the problem. The 'min' value can also be 'max' or 'zero', to test that the channel or stick is at the maximum value and 0.

The transmitter menus can be navigated by pressing the corresponding image on the screen or via the physical buttons UP, D(ow)N, L(eft), R(ight), ENT(er), EX(i)T. All buttons and switches have been marked with the same descriptions as used in this manual.

There are several GUI elements that are used to configure settings on the transmitter

Buttons: Buttons can be selected to either toggle a setting or to enter a new menu.

Spin-Boxes: Spin-boxes are used to select one of multiple values.

There are two types of spin-boxes available:

1. Spin-boxes consisting of both arrows and a 3d button may act both as spin-boxes (for selecting a value) and as a button (which can have various effects).
2. Spin-boxes that contain only arrows and a white label do not act as buttons, and are only used for value selection.

Note that a spin-box may change between being selectable or not for different values of the spin-box.

Text Boxes: Text boxes generally provide information, however in some cases they can be pressed to perform an action (like a button)

Icons: Icons can either provide information or be pressed to perform an action (like a button)



6.1 Navigating with the physical buttons

- On all menu pages, 'UP' and 'DN' are used to navigate to the previous/next item.
- The 'R+' and 'L-' buttons are used on spin-box widgets to increase or decrease the selected value. In some cases holding down the button will use larger step values to move more quickly to the desired value.
- For buttons and rounded-spin-boxes, pressing 'ENT' will press the button,
- Pressing 'EXT' will remove selection from the current item. A long-press of 'EXT' will exit one (1) menu level.

6.2 Menu Layout

There are 2 different unconnected menus available:

- The transmitter menu allows you to select transmitter-specific options as well as monitor channel output & stick input, and monitor telemetry (if available). Details of the menu are located in section *Transmitter Menu*.
- The model menu is the area within deviation that you can configure the type of aircraft you are flying. All model data is managed and saved within this menu selection. Details of the menu are located in section *Model menu*.

Transmitter Menu

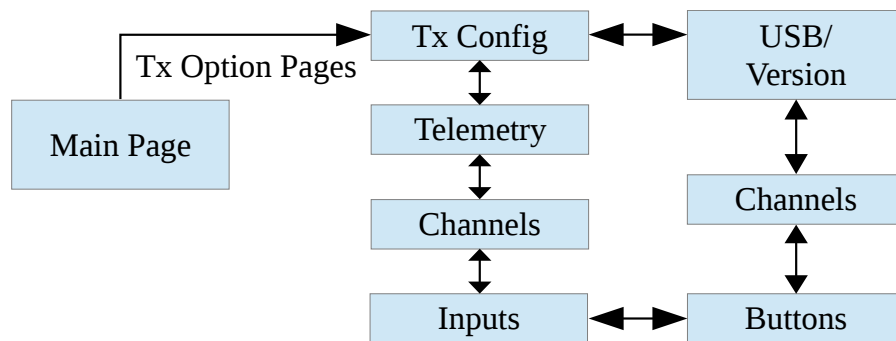

7.1 Transmitter config

The configuration page defines various transmitter functions. It is entered from the main menu via the TX Options icon. Please note that all screens in this section show the Deviation default settings.

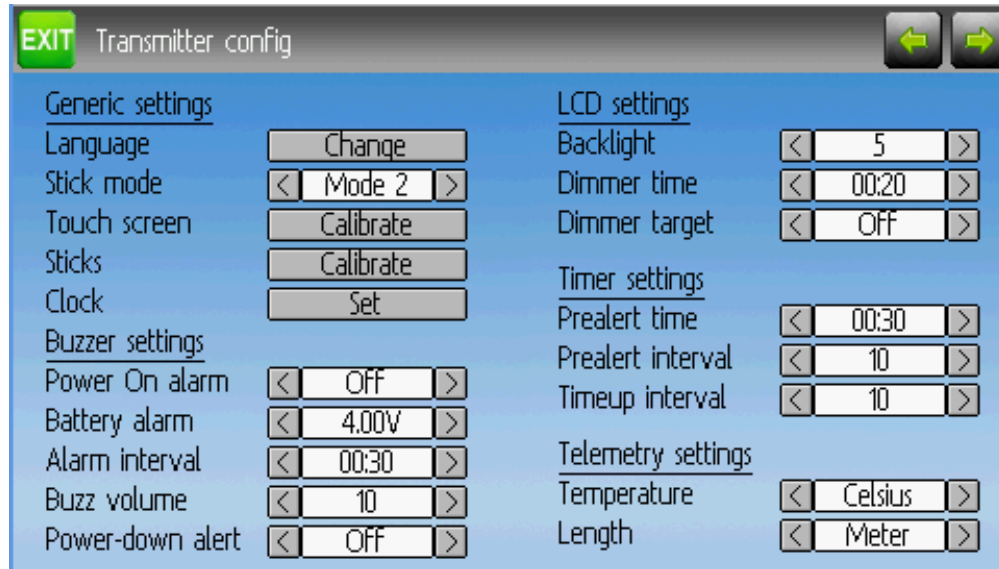

7.1.1 Generic settings

Language: Select an appropriate language for all text.

NOTE: This feature is not available for Devo7e.

Stick mode: Select one of Mode 1-4.

- Mode 1 is common in Europe. Elevator and Rudder on left, Throttle and Aileron on right.
- Mode 2 is common in North America. Throttle and Rudder on left, Elevator and Aileron on right.
- Mode 3 has Elevator and Aileron on left, Throttle and Rudder on right
- Mode 4 has Throttle and Aileron on left, Elevator and Rudder on right

Sticks: Calibrate the range of all analog sticks and dials.

To perform a stick calibration, highlight the Calibrate option and press the ENT button. Follow the on screen prompts for moving the sticks and confirming with the ENT button.

Clock (Devo12 only): Set the current time and date

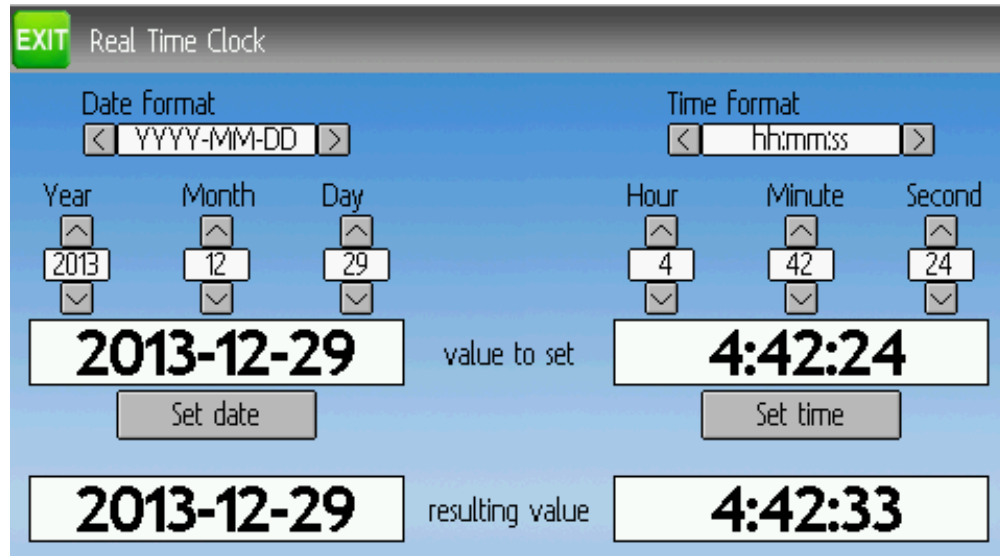

7.1.2 Buzzer settings

Power On alarm: Select the interval to be notified if your transmitter is on without action. Range is 0 – 60 minutes in 1 minute intervals.

Battery alarm: Set battery voltage at which alarm will sound. The voltage range is 3.30V – 12.00V in 0.01V increments.

Alarm interval: Set frequency of alarm when battery is low. Alarm intervals can be set from 5 seconds to 1 minute in 5 second intervals. It may also be set to Off.

Buzz volume: Set buzzer volume. Available range is 1 – 10; the buzzer may also be set to None.

Vibration: Enable vibration on alarms, if available.

Power-down alert: Play sound at power-down.

7.1.3 LCD settings

Backlight: Set screen brightness. Acceptable entries are from 1 to 10.

Contrast: Set screen contrast. Acceptable entries are from 1 to 10.

Dimmer time: Set delay before screen dimming. Times may be set from 5 seconds to 2 minutes in 5 second intervals. A setting of Off will force backlight to remain on as long as the transmitter is on.

Dimmer target: Set screen brightness when dimmed. Acceptable entries are from 1 to 10 and may also be turned off.

7.1.4 Timer settings

Prealert time: Time before timer reaches zero to start beeping. Acceptable entries are from 5 seconds to 1 minute in 5 second intervals and may also be turned off.

Prealert intvl: How often to beep before timer reaches zero. Interval may be set from 1 – 60 seconds and may also be turned off.

Timeup intvl: How often to beep once timer has expired. Interval may be set from 1 – 60 seconds and may also be turned off.

7.1.5 Telemetry settings

Temperature: Set units to display temperature for telemetry. Available options are Celsius and Fahrenheit.

Length: Set units to display length for telemetry. Selection choices are Meters and Feet.

7.2 Channel monitor

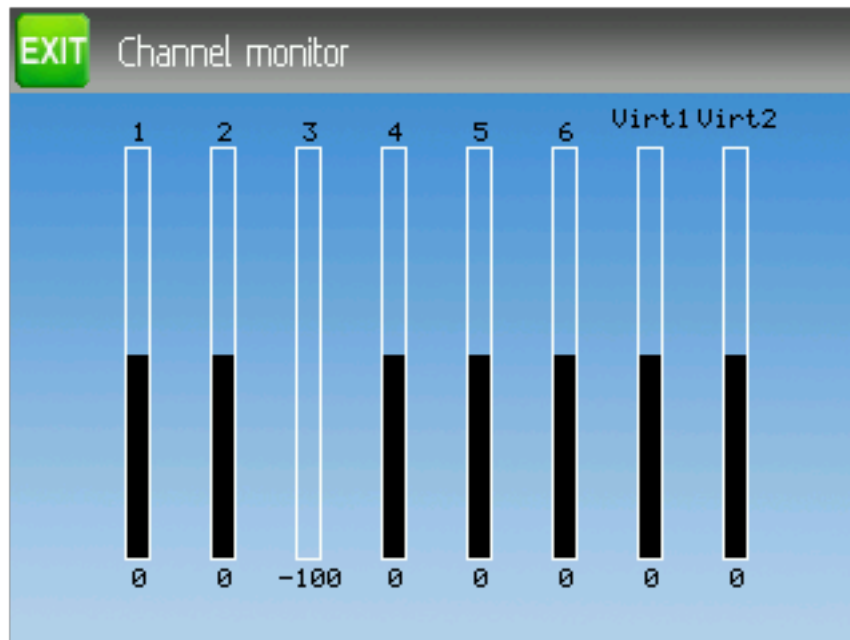

The channel monitor screen allows the user to see the values of each channel as output by the transmitter. Channels without mixers will not be displayed. Channel output displayed is the value based on minimum / maximum values as well as scaling.

Example: A channel scaled from -60 to +60 will only display the range of values from -60 to +60 depending on the stick position.

7.3 Input Monitor

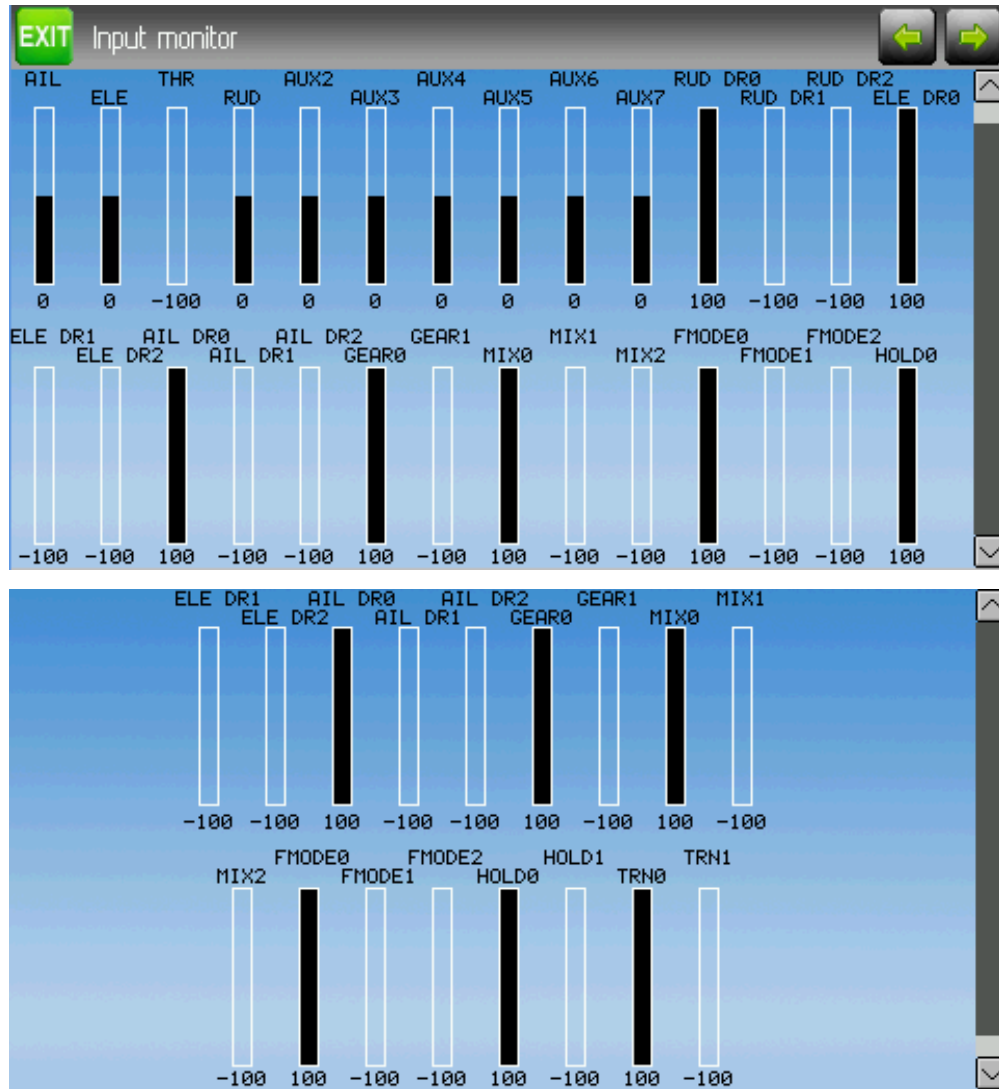

The input monitor screen shows the values associated with the current position of the control points. The values shown are a percentage of the total range of the controls based on a -100% to +100% scale.

NOTE: Devo8 is limited to AIL, ELE, THR, RUD, RUD DR0/1, ELE DR0/1, AIL DR0/1, GEAR0/1, FMODE0/1/2, and MIX0/1/2

NOTE: Devo6 is limited to AIL, ELE, THR, RUD, DR0/1, GEAR0/1, FMODE0/1/2, and MIX0/1/2

7.4 Button Monitor

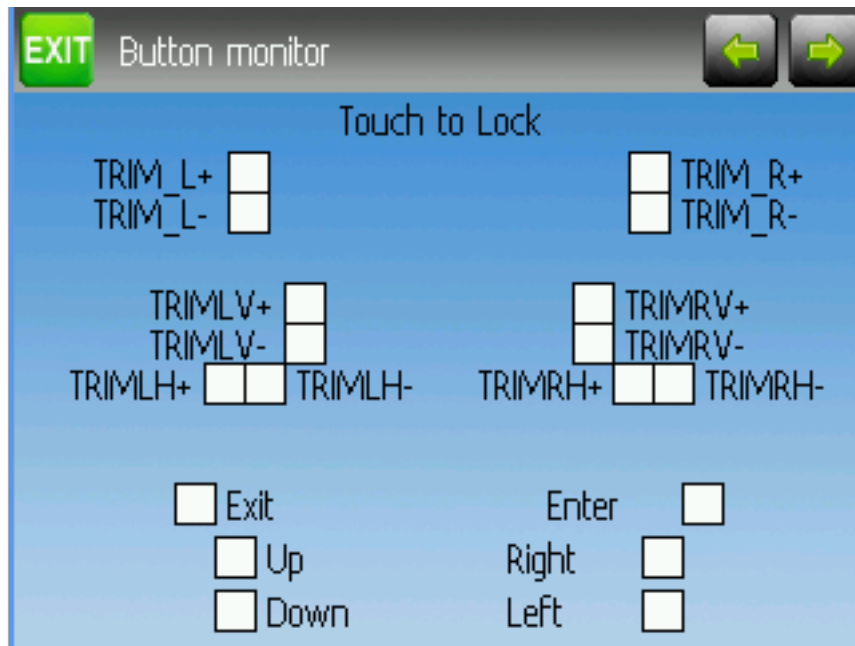

The button monitor page is used to ensure physical buttons on the transmitter are working as expected. Pressing any physical button will select the corresponding square on the screen. To test 'EXT', 'L-' or 'R+' touch the screen to disable menu traversal. Touch the screen again to unlock.

NOTE: Devo6 does not have the upper set of Trim L/R buttons

7.5 Telemetry monitor

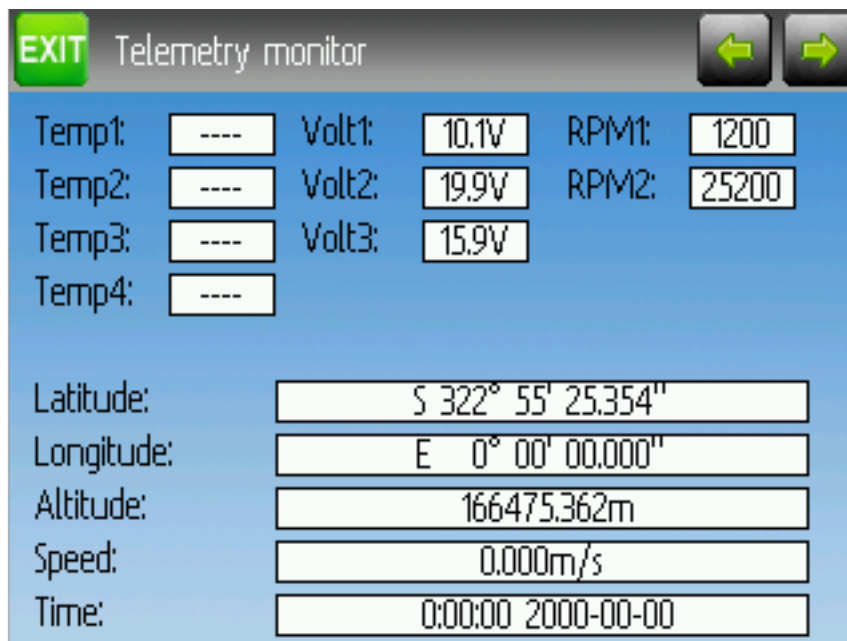

Certain protocols have the ability to transmit telemetry data back to the transmitter during use. Telemetry data may include, but is not restricted to, temperature readings, various voltage readings, motor or engine rpm, as well as GPS related information.

Telemetry data is turned off by default for all supported protocols except DEVO and FrSky. See the corresponding 9 Protocols section to learn which protocols support telemetry, and identify which fields will be available.



Since each protocol differs in the type of data it can return please see the original equipment manufacturers

documentation concerning what additional hardware may be needed to collect this data.
Until valid data is transmitted the values will all be red.

7.6 Range Test

It is recommended that you range test a new model before flying it the first time to verify that you will be able to control the model at normal flying distances. At some clubs, this is required as a safety measure. The range test page allows this.

Once the range test page is opened, press the 'Start test' button to start the range test. The old and new power levels will be displayed. The standard procedure is then to walk about 30 meters away, and verify that you still have control of the aircraft. You can then press the 'Stop test' button to end the range test and restore the configured radio power level. Pressing the 'Ext' button to exit the page will also restore the power level.

The radio range will be reduced by the square root of the change in power level. So going from 100mW to 100uW represents a change of power of roughly 1000, or a range reduction of a factor of a little over 30. So the normal range test of 30 meters would indicate that you should be able to control the model out to 900 meters.

The installed RF module used for the current model must have a PA. If that is not the case, or the power level chosen for the model is already at the minimum value, a message to that effect will be displayed.

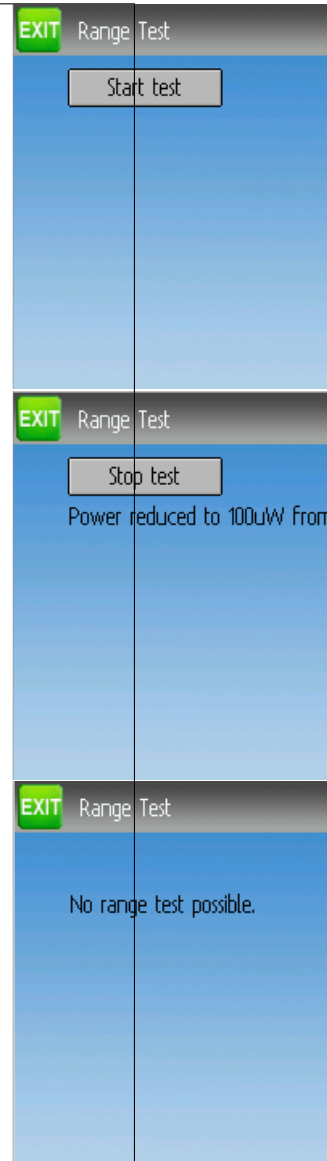

7.7 USB/About



The USB page can be accessed by selecting 'USB' from the main menu. USB mode can then be toggled on/off to enable access to the transmitter's file-system from a USB equipped computer. In this mode the file system of Deviation is accessible as a mass storage device. This will allow you to move files back and forth between the Deviation file-system and a PC. All configuration files are accessible in this mode.

NOTE: Entering USB mode should never be done while the model is bound, USB usage will disrupt signal transmission!

The model menu allows selection, editing model configuration, alarms, logging and screen configurations. You can access the menu by pressing the ENT key to select the 'Main menu' and then again on 'Model menu'.

Depending on the selection you have done for the Mixer GUI in section *Model setup (Std & Adv GUI)*, the model menu operation will be completely different.

Advanced GUI:

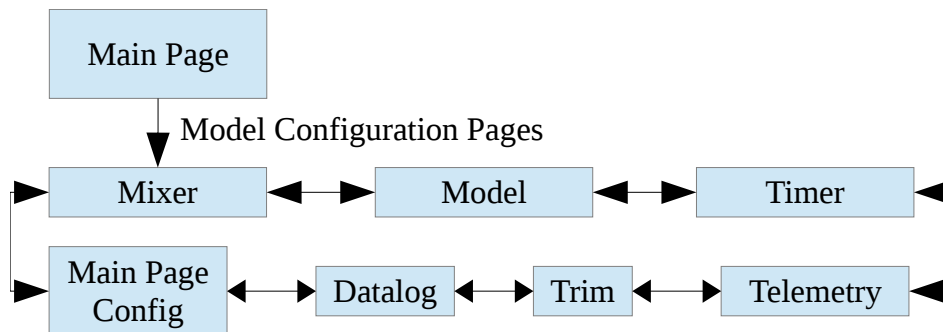

Standard GUI:



Note: The Advanced Mixer GUI is the default setting for all new models.

8.1 Model setup (Std & Adv GUI)

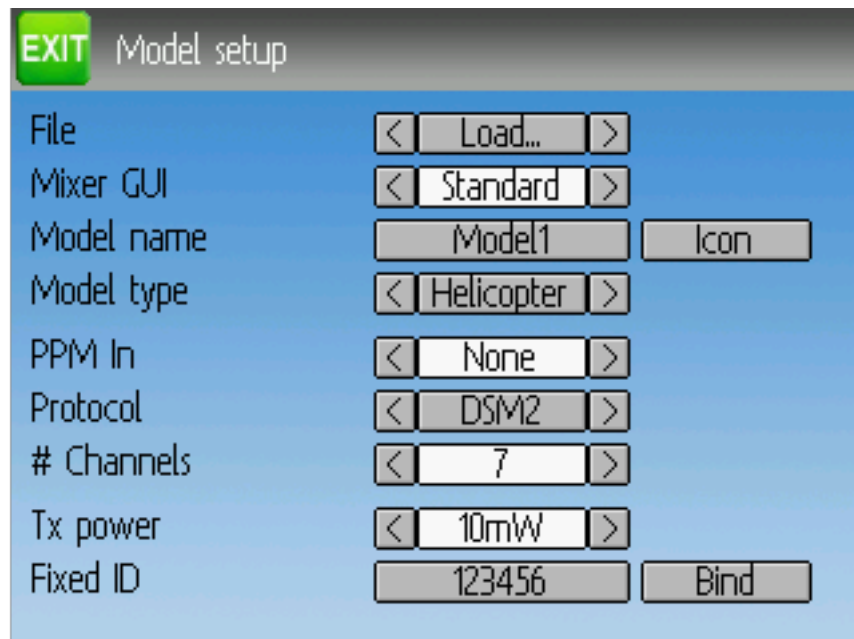

The model page provides various model configuration options.

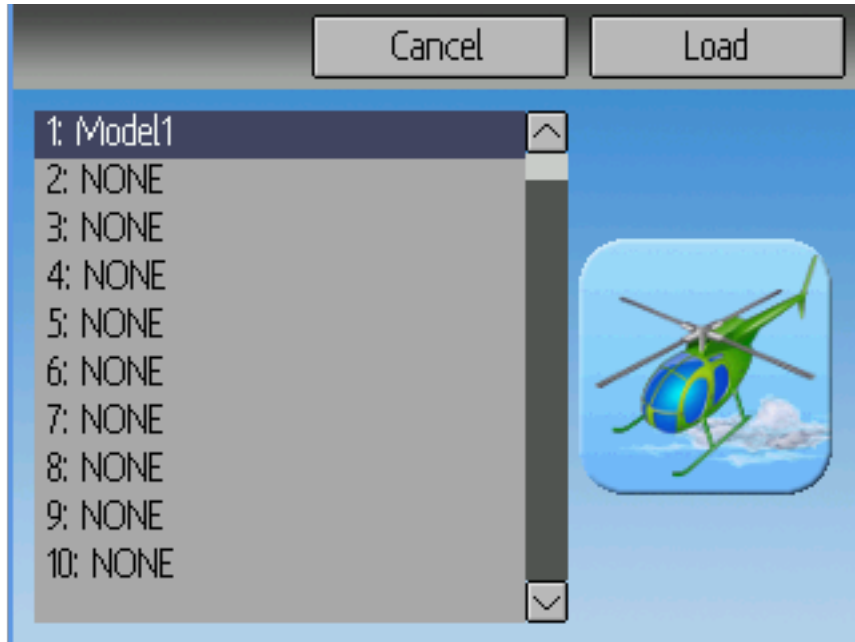

File: The File spin-box allows loading a new model, copying the existing model to a new location, resetting the current model to the default (all configuration is lost), and loading templates (see *Predefined Model Templates*). Note that changing models may result in a safety message being displayed (see *Safety System*).



Mixer GUI: Defines which graphical user interface (GUI) to use for this model. The ‘Advanced’ GUI is the default for Deviation. The ‘Standard’ GUI is only available for Helicopter models and more closely resembles the stock GUI.

Standard mixer gui is designed for collective pitch helicopters with a flybar. It includes features specific to those that aren’t needed on other aircraft, and may be missing features needed to properly control other aircraft. A flybarless collective pitch helicopter might benefit from some of the features of the standard GUI, it doesn’t need them and may need those missing features. **You are strongly encouraged to use advanced mixer for all aircraft but collective pitch helicopters.**

Note: If you switch from advanced mixer to standard mixer all data may be lost. Your data will be preserved if you switch from standard mixer to advanced mixer.



Model Name: Set the model's name. Use the left, right, up, and down buttons then ENT to select each character.

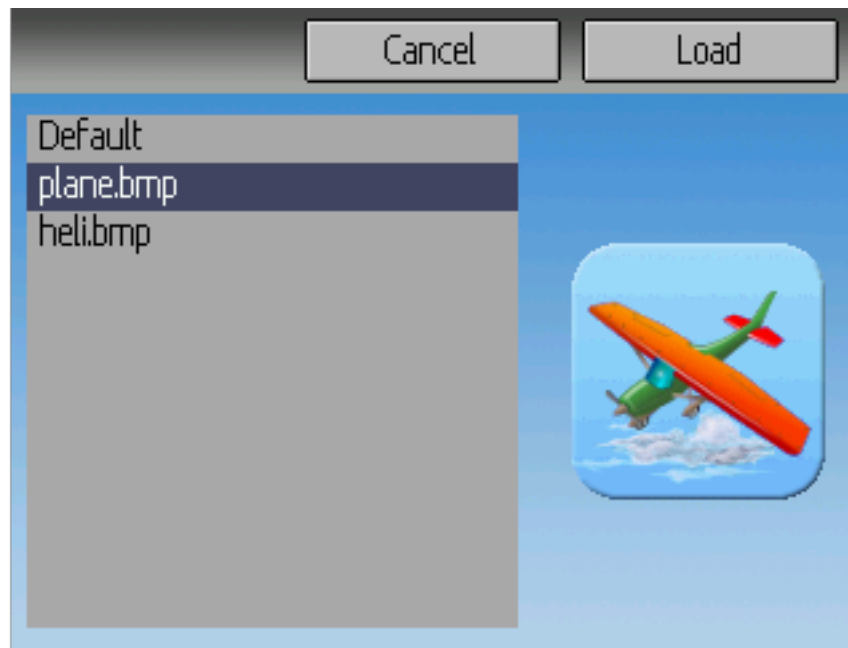

Icon: Choose the model's icon. Additional model icons can be installed (see *USB & File-system*).

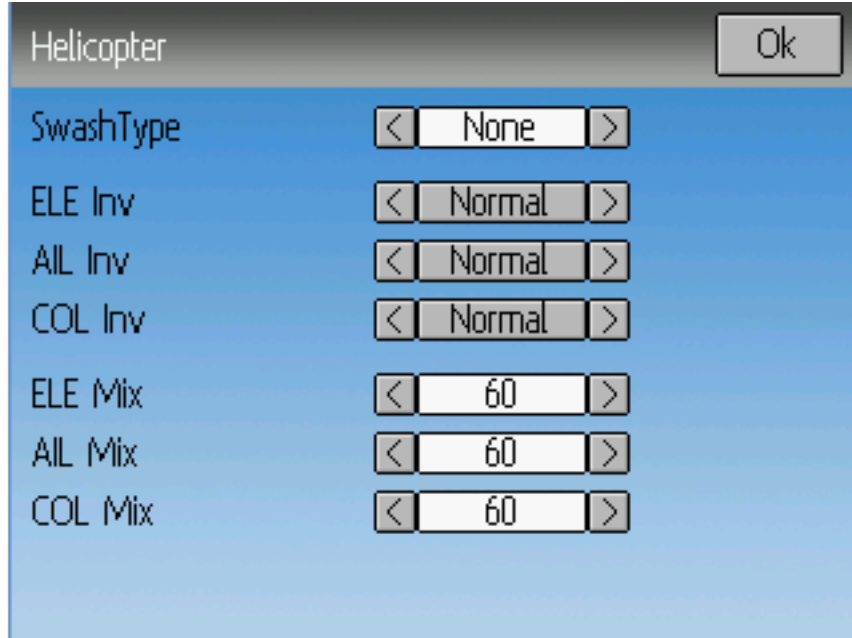

Model Type: Set the model-type available options are Heli, Plane and Multi. Helicopter models have an additional configuration page that can be accessed by clicking the Model type. The options for SwashType are identical to the ones in *Swash Configuration*.

If you switch from model type Helicopter this will change the Mixer GUI to Advanced automatically because the Standard GUI only supports helicopters.

Transmitter Power: Specify the radio output power (when applicable). The valid power settings depend on the radio used by the selected protocol.

CYRF6936, CC2500, MULTIMOD	100µW, 300µW, 1mW, 3mW, 10mW, 30mW, 100mW, 150mW
A7105	100µW, 300µW, 1mW, 3mW, 10mW, 30mW, 100mW
NRF24L01	1mW, 6mW, 25mW, 100mW
R9M (PXX protocol)	10/25mW, 100/25mW, 500/500, Auto/200 (FCC/EU)

When changing the protocol in a model the power level will be set to the maximum for the radio used by the new protocol. Best to choose protocol first, then set Tx power.

PPM In: Allows input from the DSC port primarily to control external hardware such as camera motors from a ‘head tracker’. Secondly it may be used to enable the transmitter to act as a Master in a buddy-box setup. Available options are Channel, Stick and Extend.

The Stick and Channel modes are used for buddy-box setup and documentation can be found in chapter *Setting up a Buddy-Box*. The Extend mode is used for FPV or external input setup and documentation can be found in chapter *Setting Up FPV or Other External Inputs*.

Protocol: Set the type of receiver being used. Note that some protocols have additional options that can be accessed by pressing the Protocol spin-box when it is active. See section *Protocols* for more on specific protocols. Note that a protocol change will disable any currently active protocol and will affect any active model. To enable the newly chosen protocol, use the Bind/Re-Init button described below.

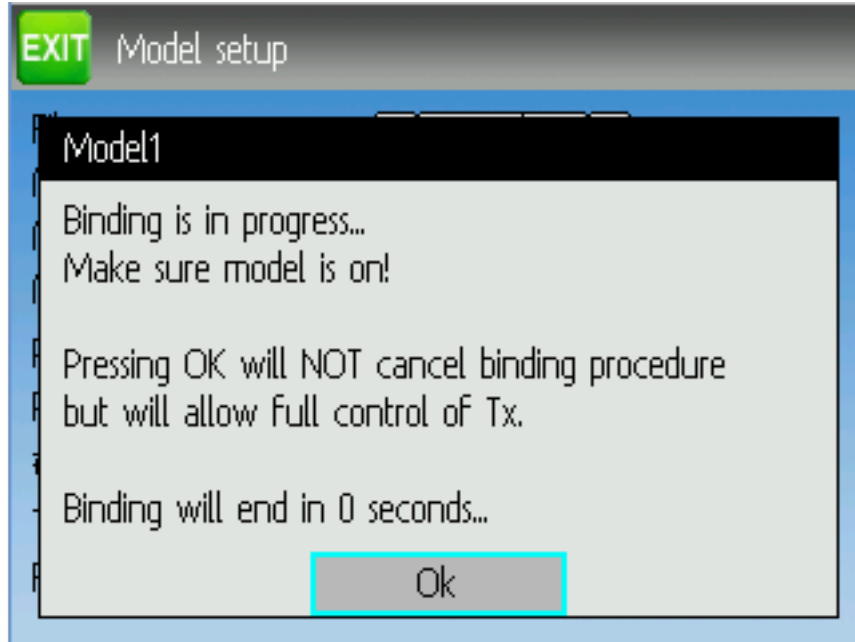

Bind/Re-Init: Depending on the protocol and Fixed-ID setting, the transmitter may bind with the model on start-up, or may need to be manually bound once. See *Protocols* for more on specific protocols. If the protocol does not support binding, the button will show 'Re-Init', which can be used to switch protocols without power-cycling the transmitter.

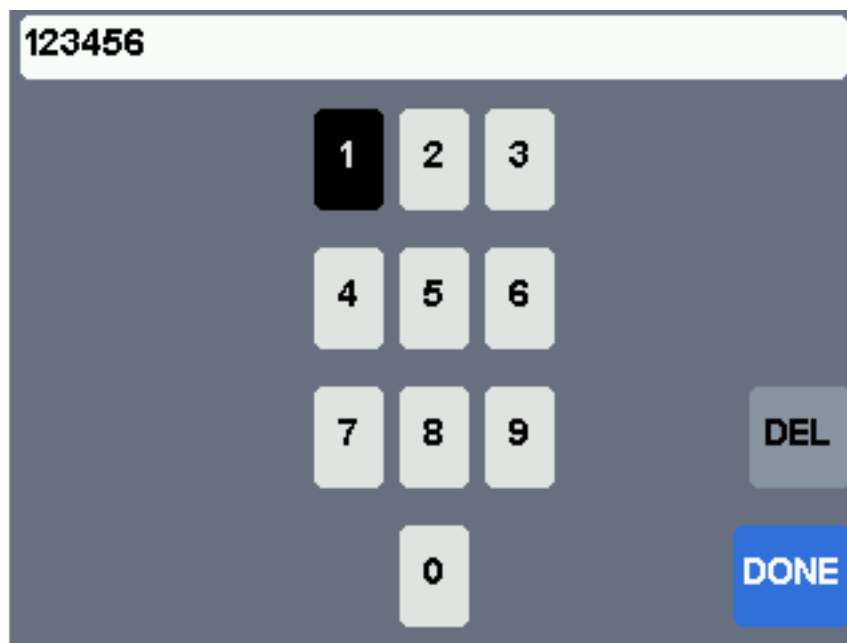

Fixed ID: The Fixed ID sets a unique code to ensure that the transmitter will only bind to a specific model. This is useful to ensure that the transmitter is not accidentally bound to the wrong model.

Channels: Sets the number of channels to transmit (the maximum number of channels is dependent on the selected protocol).

8.1.1 Predefined Model Templates

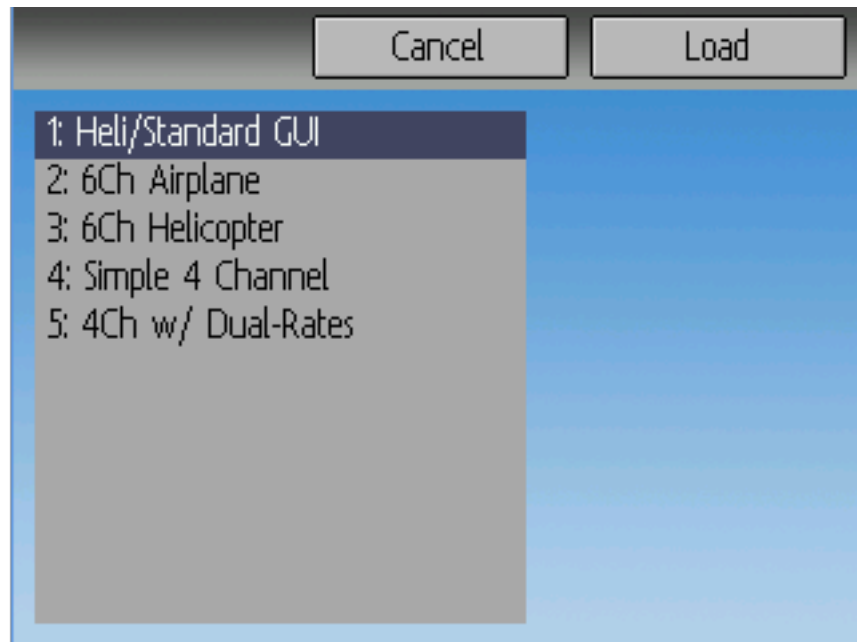

The Deviation firmware supports user-customizable predefined templates. By Selecting 'Template...' within the File spin-box from the Model page.

Additional templates can be added via USB to the 'template' directory. A template does not completely replace your existing model, but instead only a portion of it. The currently supported templates will replace the mixer and trim definitions, but will not affect the display layout.

8.2 Mixer (Adv GUI)

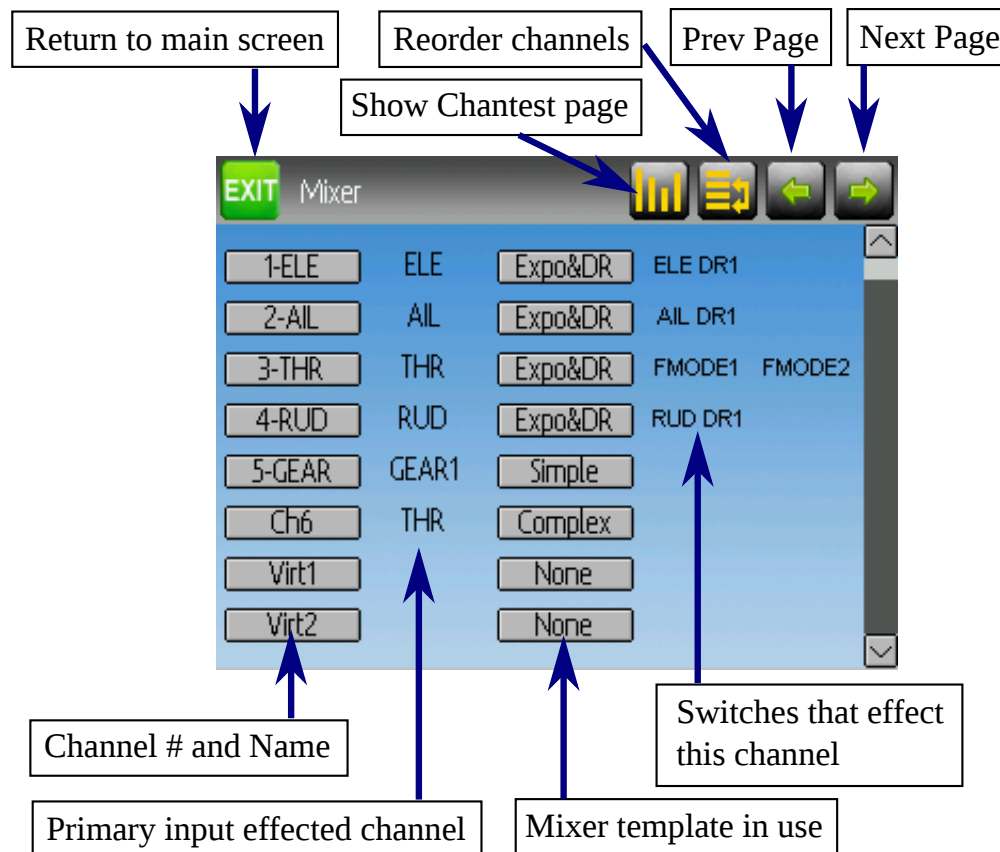

The 'Advanced' GUI unleashes the full capabilities of the Deviation firmware, however it is unlike any commercial transmitter setup. Deviation also provides a more traditional setup interface for those who prefer it (see *Standard GUI Menu items*). With the Advanced GUI, each output channel is composed of a series of one or more mixers each of which consists of a single input, an activation switch, and a function/curve that modifies the mixer output. This is a very powerful capability, but it will require learning a completely different method for setting up a model. To aid in quick setup, there are a few predefined configurations available (see *Predefined Model Templates*), but to learn to modify and configure a model, read through this entire section carefully.

The Mixer page controls how inputs (sticks/switches) are assigned to output channels. The mixer page is accessed from the main menu by selecting the model icon..

The number of channels available is dependent on the number of channels selected in section *Model setup (Std & Adv GUI)*. Additionally there are 10 Virtual channels that can be used as an intermediate step for complex setups.

8.2.1 Channel Reorder

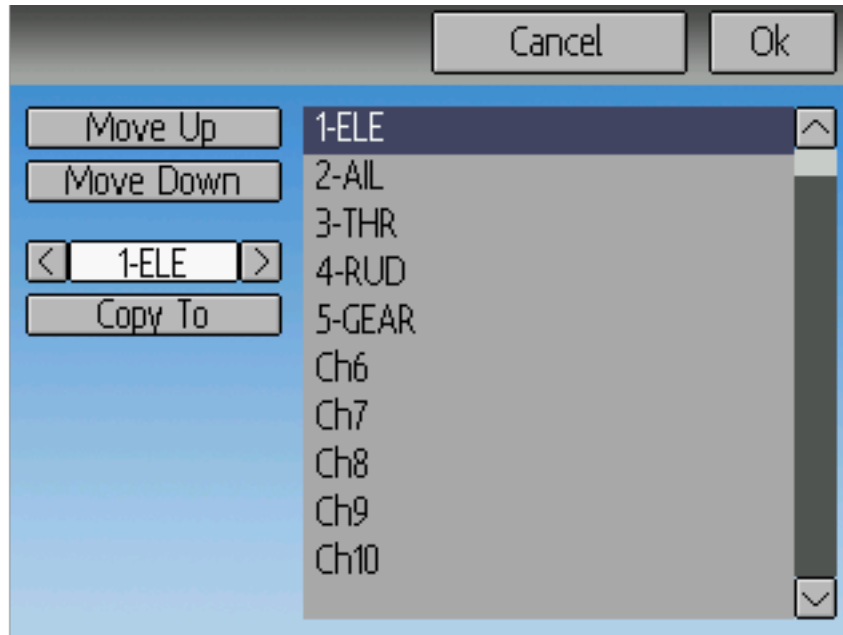

The Channel reorder page allows moving mixer definitions between channels as well as duplicating channel configurations. Note that the values displayed are the initial channel assignments. Whenever the page is loaded, the channels will be sequentially ordered representing the current state.

8.2.2 Channel configuration

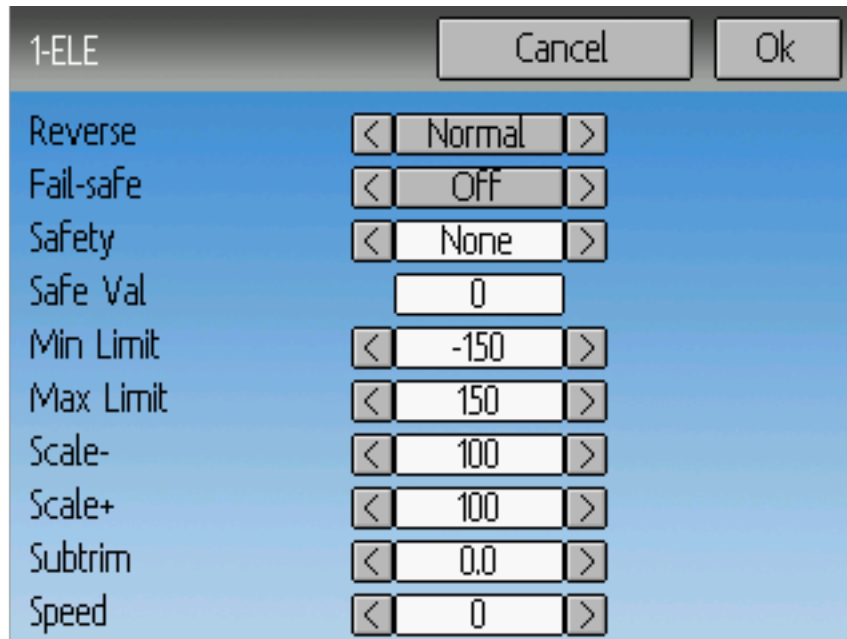

The Channel configuration provides the ability to configure the final channel outputs. Capabilities such as channel reverse and fail-safe values are applied here. Also available are controls for end-points, scaling,

sub-trim, and a safety switch (which could be used to ensure that a motor cannot spin-up while working on a model)

Changes to this page will immediately effect the channel output. Pressing '**Cancel**' will restore the shown values to their last saved state.

Reverse: Reverse the direction of servo rotation

Fail-safe: Specifies a value that the receiver should use when it loses signal from the transmitter. The range is between -125 and +125 or None. Not all receivers support this capability.

Safety: Specifies a switch that will override all mixers and force the channel output to 'Safe Val' when flipped.

Safe Val: If a safety switch is chosen the Safe Val can also be specified. The acceptable range of Safe Val is any value between -150 and 150.

Min Limit/Max Limit: These values define the minimum and maximum values that the transmitter will ever send to the receiver (after all scaling, trims and mixer are applied). If a calculated value is outside the min/max range, it will be clipped to either the min or max value as appropriate. Default is -150 for Min Limit and +150 for Max Limit. Maximum setting is -250 to 0 for Min Limit and 0 to 250 for Max Limit.

Scale-/Scale+: These values define a final scalar to adjust the servo throw. Allowed entries are between 1 and 250. When you alternate Scale+ Scale- will be changed in the same way. If Scale- has been set to a different value than Scale+ both data will act separately until you set them to the same value again.

Subtrim: Adjust servo zero position. The available range is between -50.0 and +50.0 in 0.1 increments.

Speed: Adjust maximum servo speed. Zero is disabled (fastest), Range is between 1 (slowest) and 250 (fastest). Servo speed is defined as number of degrees per 100msec (assuming a min/max throw of 120degrees).

Example: A value of 60 will give a speed of 60degrees per 100msec which is equivalent to center-to max in 100msec. Most servos are rated at ~60degrees/0.1sec, so a speed > 60 will have no affect on most servos. A value of 30 should be approx twice as slow as a typical servo.

8.2.3 Virtual channel configuration

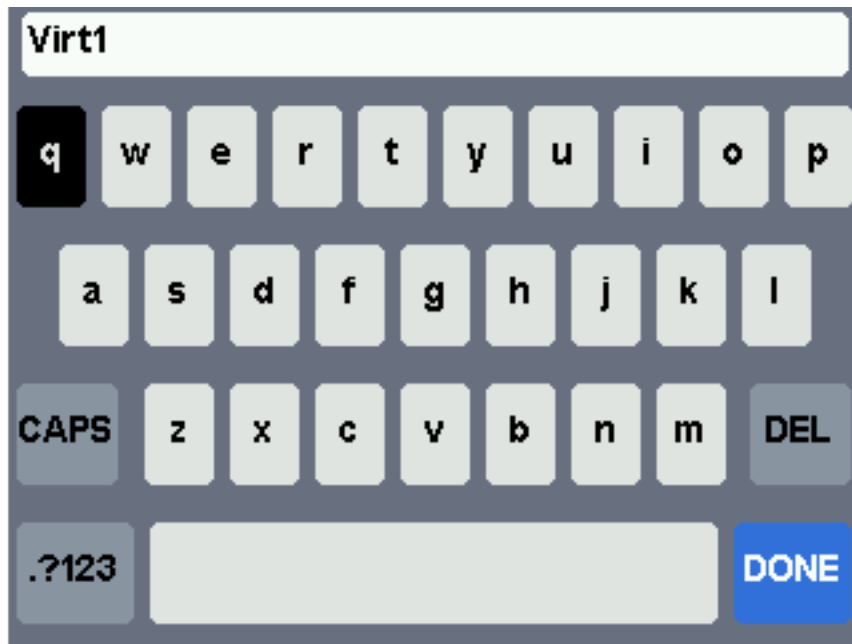

If you press ENT on a virtual channel a keyboard screen is shown where you may edit the default name. You can use L/R/UP/DN buttons followed by 'ENT' to select. Or just touch each character.

8.2.4 Simple Mix Type

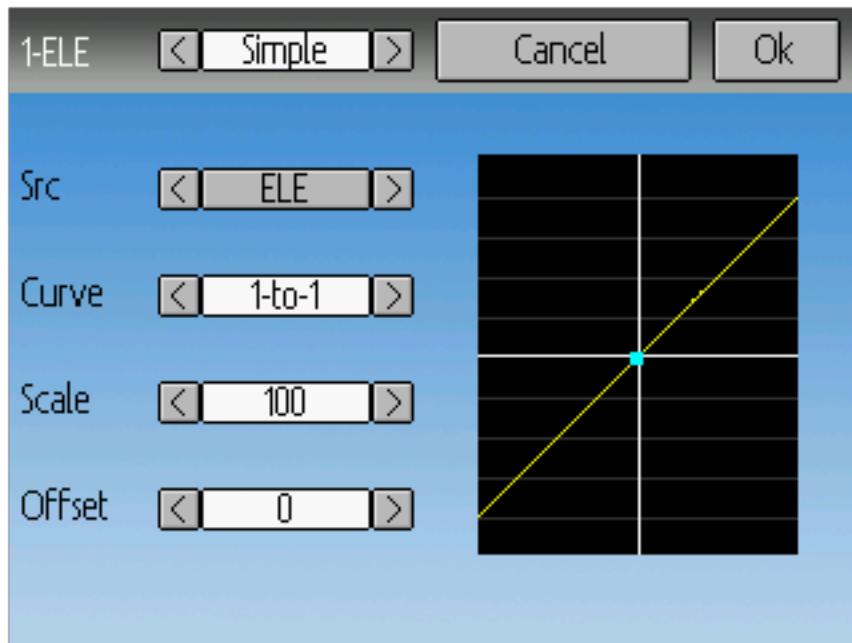

The Simple mix type is the simplest manner of defining a channel. It allows defining a primary-input (stick, switch, or other channel), and applying a curve or function to that input. The result can also be scaled or have an alternate zero-offset. You cannot use a toggle or switch to activate or deactivate this setup.

A ‘Long-ENT’ press will update the current mixer settings, making it possible to test them on the transmitter.

Src: The input source controlling this mixer.

Curve: The function applied to the input to generate the output. See section *Available Curves* for more info. Depending on curve-type, pressing curve may display the curve editor (see *Curve Editing*).

Scale: A multiplicative scalar that is applied after the Curve to control the output range.

Offset: An additive offset that is applied after the scaling.

8.2.5 Expo & Dual-Rate Mix Type

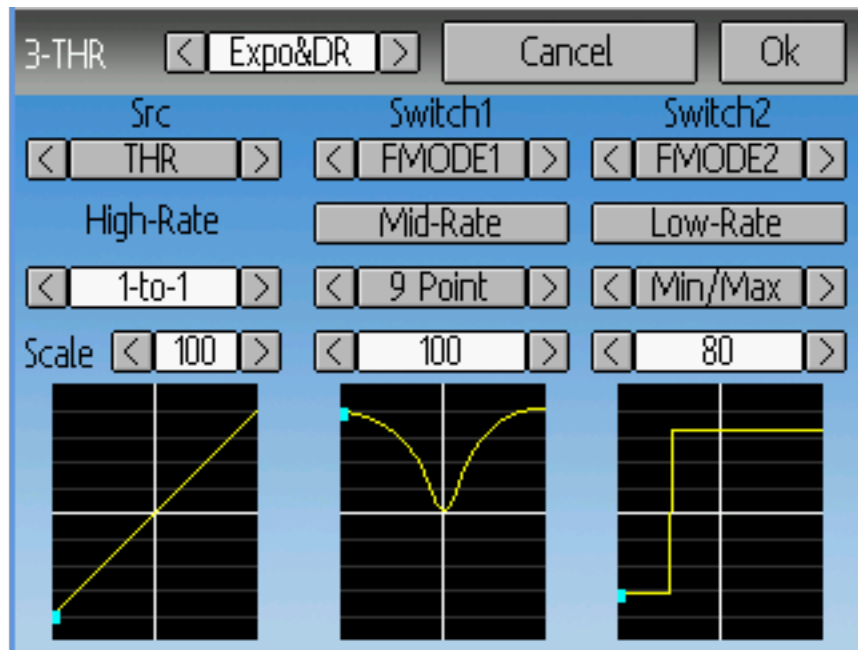

Selecting a value for Switch1 or Switch2 will activate the corresponding section. Each section can either have a ‘linked’ curve (curve is the same as the ‘High-Rate’ curve) in which case only the scalar can be modified, or alternatively can have an independent curve definition. Pressing the ‘Mid-Rate’ or ‘Low-Rate’ button for a given switch will toggle between linked and independent curves.

A ‘Long-ENT’ press will update the current mixer settings, making it possible to test them on the transmitter.

Src: The input source controlling this mixer.

Curve: The function applied to the input to generate the output. See section *Available Curves* for more info. Depending on curve-type, pressing curve may display the curve editor (see *Curve Editing*).

Switch1 or **Switch2:** Specify a switch to enable Medium or Low rates.

Scale: A multiplicative scalar that is applied after the Curve to control the output range.

8.2.6 Complex Mix Type

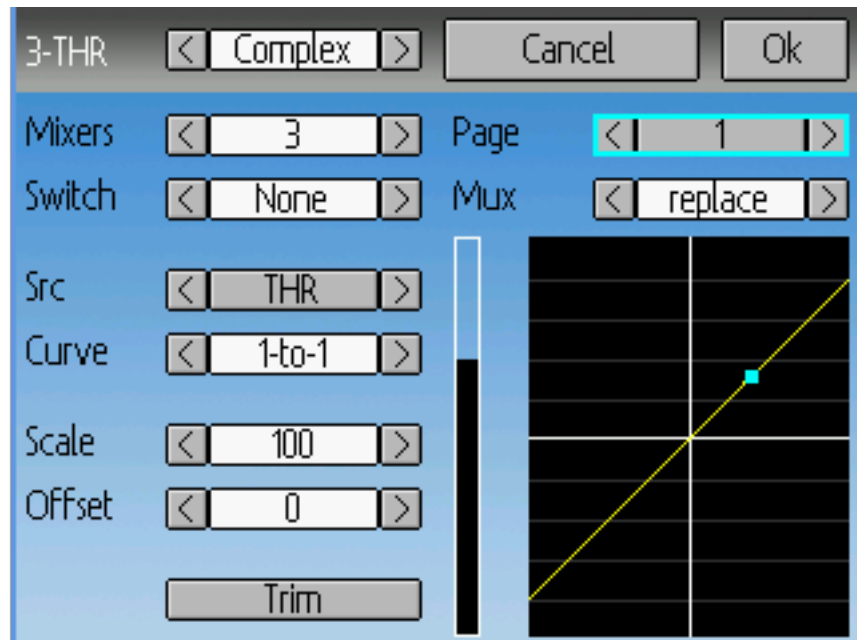

The Complex mix type unlocks the full power of the mixer system. For a given channel, any number of mixers can be applied to affect the final result. Each mixer is applied based on whether the specified switch is active, and can either replace, add to, or multiply to the previous mixers for this channel. Using this system it should be possible to define an output channel as a combination of any number of inputs.

A 'Long-ENT' press will update the current mixer settings, making it possible to test them on the transmitter.

The Complex Mixer page has the following options:

Mixers: Specify the number of mixers for this channel. If you increase the number a new mixer will be added after the last existing page.

Page: Specify the current mixer page being edited. Pressing the spin-box will allow reordering the pages of the current channel.

Switch: Specify an optional switch which determines whether the current mixer is active.

Mux: Defines how the current mixer is applied to the previously defined mixers for this channel. Options are:

- **Replace:** If this mixer is active, all previous mixers are ignored.
- **Add:** Add the value of this mixer to the previous mixers.
- **Mult:** Multiply the value of this mixer with the previous mixers. Note that the values are percentages, so multiplying by 50 actually multiplies by .5.
- **Max:** The output will be the greater of the current mixer vs the previous mixers.
- **Min:** The output will be the lesser of the current mixer vs the previous mixers.
- **Delay:** Delay the output of this mixer when used with a fixed curve. Scale of 100 represents 5 seconds delay. Can be varied by using scale or offset.

Src: The input source controlling this mixer.

Curve: The function applied to the input to generate the output. See section [Available Curves](#) for more info. Depending on curve-type, pressing curve may display the curve editor (see [Curve Editing](#)).

Scale: A multiplicative scalar that is applied after the Curve to control the output range.

Note that while the scale value is limited to 100%, the mixer may provide a value larger than 100% if an offset is set or if the trim value is non-zero.

Offset: an additive offset that is applied after the scaling.

Trim: Selects whether or not any trims for the selected source are applied to this mixer.

A given mixer can be considered to have the general form:

$$M(x) = \text{if}(\text{Switch}) \{ \text{Src} * \text{Curve} * \text{Scale} + \text{Offset} \} \text{ else } \{0\} + \text{Trim}$$

The combination of mixers for a given output channel is defined by the Mux type:

For a 'Replace' mux:

$$C_x = \text{if}(\text{Switch}_n) \{M_n\} \text{ else if } (\text{Switch}_{n-1}) \{M_{n-1}\} \dots \text{ else if } (\text{Switch}_0) \{M_0\}$$

For a 'Multiply' mux:

$$C_x = \text{if}(\text{Switch}_n) \{M_n\} \text{ else } \{1\} * \text{if}(\text{Switch}_{n-1}) \{M_{n-1}\} \text{ else } \{1\} * \dots * \text{if}(\text{Switch}_0) \{M_0\} \text{ else } \{1\}$$

For an 'Add' mux:

$$C_x = \text{if}(\text{Switch}_n) \{M_n\} \text{ else } \{0\} + \text{if}(\text{Switch}_{n-1}) \{M_{n-1}\} \text{ else } \{0\} + \dots + \text{if}(\text{Switch}_0) \{M_0\} \text{ else } \{0\}$$

For a 'Max' mux:

$$C_x = \text{MAX}(\text{if}(\text{Switch}_n) \{M_n\} \text{ else } \{0\}, \text{if}(\text{Switch}_{n-1}) \{M_{n-1}\} \text{ else } \{0\}, \dots, \text{if}(\text{Switch}_0) \{M_0\} \text{ else } \{0\})$$

For a 'Min' mux:

$$C_x = \text{MIN}(\text{if}(\text{Switch}_n) \{M_n\} \text{ else } \{0\}, \text{if}(\text{Switch}_{n-1}) \{M_{n-1}\} \text{ else } \{0\}, \dots, \text{if}(\text{Switch}_0) \{M_0\} \text{ else } \{0\})$$

8.2.7 Cyclic

Cyclic1, Cyclic2, Cyclic3: The 3 outputs of the helicopter swash-plate mix. These will represent the 3 servos connected to the helicopter swash-plate (see [Swash Configuration](#)).

8.2.8 Reordering Mixers



Select the respective mixer and use the up/down buttons to move the order of the selected mixer. Note that the mixer name represents its position when the reorder dialog was opened. If the dialog is closed and reopened, all mixers will be shown as numbered sequentially.

The reorder page can add new mixers or delete existing ones using the '+' and '-' buttons respectively. A mixer can also be copied to an existing mixer (overwriting it in the process) by using the 'Copy To' functionality.

8.2.9 Available Curves

The following curve functions are supported:

- **1-to-1**: Output is equal to the input (not editable).
- **Fixed**: Output is constant regardless of input (offset editable).
- **Min/Max**: Output is -100 if input is less than the specified value and 100 otherwise.
- **Zero/Max**: Output is 0 if input is less than the specified value and 100 otherwise.
- **>0**: Output matches input when greater than the specified value, and 0 otherwise.
- **<0**: Output matches the input when less than the specified value, and 0 otherwise.
- **ABSVAL**: Output is the absolute-value of the input (editing the specified value will alter how the absolute-value is applied)
- **EXPO**: Apply exponential curve to the input for non-linear response (editable see *Curve Editing*).
- **Deadband**: Output will not respond to input values near zero (editable see *Curve Editing*).
- **Multi-point**: Curve is based on 3, 5, 7, 9, 11 or 13 user-defined points (editable see *Curve Editing*).

The default value for any of the offsets in above mentioned curves is 0 (zero). If you change the curve for one input the offset will be transferred to the new curve if possible.

8.2.10 Curve Editing

The Curve Editor is accessed by pressing a graph or by pressing or selecting the curve spin-box when it is selectable. The 1-1 and Fixed curve types may not be edited, and the curve-box will not be selectable if one of these curves is currently active.

The Curve editor page will be different depending on which curve is selected. It is not possible to change the curve type from the curve editor (except when a multi-point curve is selected). Values can be set using the spin-box or by touching the graph.

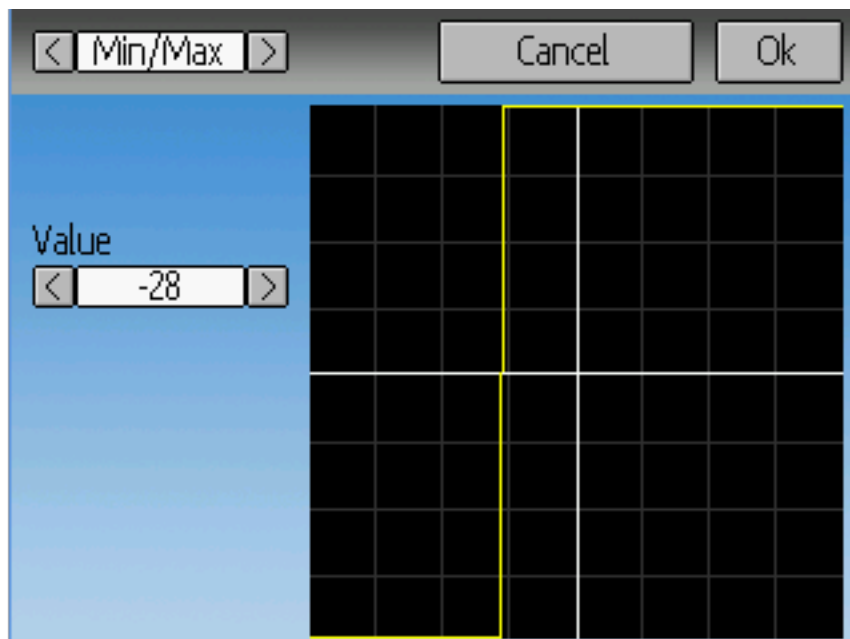

For the Min/Max, Zero/Max, >0, <0, and ABSVAL, the controls allow setting the transition point along the x-axis. A value of '0' will be symmetric around the y-axis, positive or negative values will move the center point accordingly

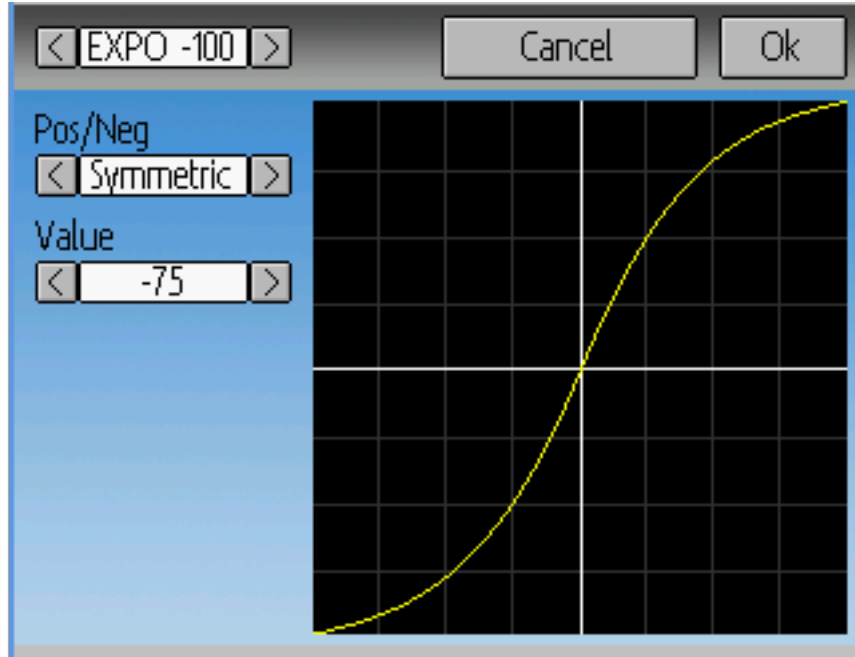

For the Expo curve, the controls allow independently configuring the shape of the curve for values greater-than or less-than zero.

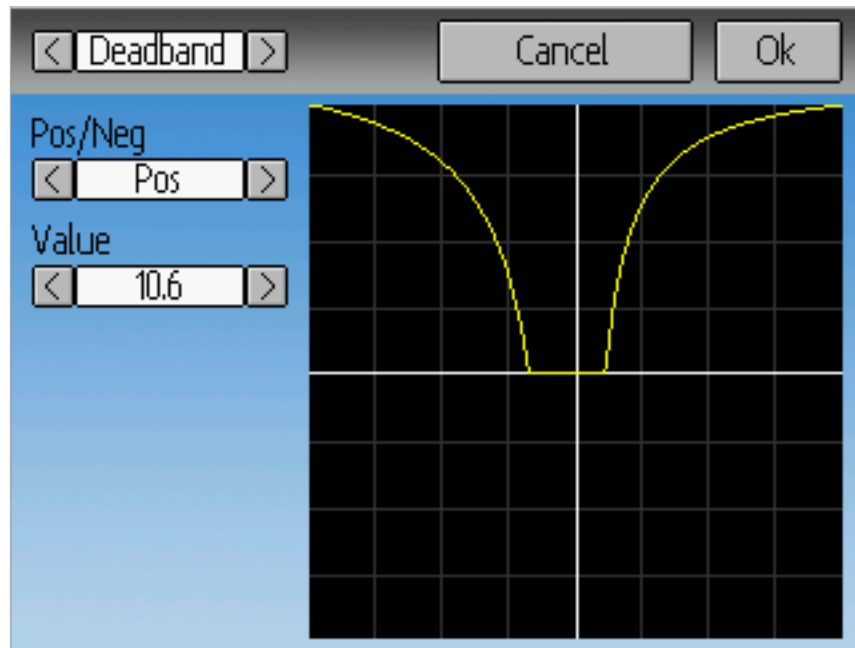

For the Deadband curve, the controls allow independently configuring the deadband width for values greater-than or less-than zero.

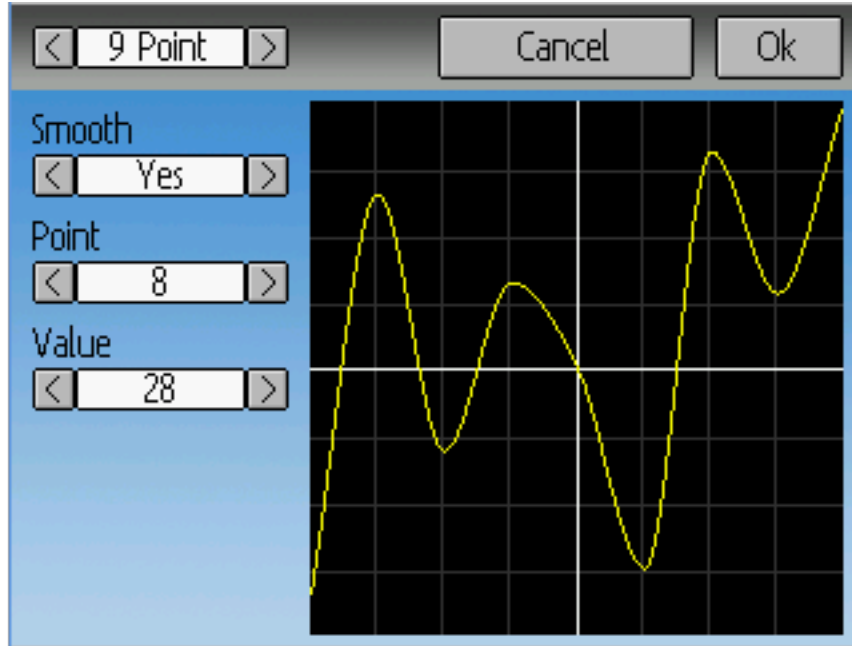

For the Multi-point curves, each point can be individually set. Points are set by choosing the point number and then choosing a value. The minimum number of points allowable is 3 the maximum number of points is 13. Enabling ‘Smooth’ will apply a smoothing function rather than connecting points via straight lines.

8.3 Timers (Std & Adv GUI)



The timer page defines up to 4 available timers. Timers can count either up or down, and can be enabled either manually from the main screen or by an input trigger (stick or switch).

Available timers are stopwatch, countdown, stopwatch-proportional, countdown-proportional, and permanent.

Timers can also be optionally configured to be reset via an alternate switch (only when using the Advanced GUI).

Both proportional timers need an input between 0 and 100 to act correctly. If you use these timer for throttle a virtual mixer must be used as the input to scale -100 to 100 values into 0 to 100.

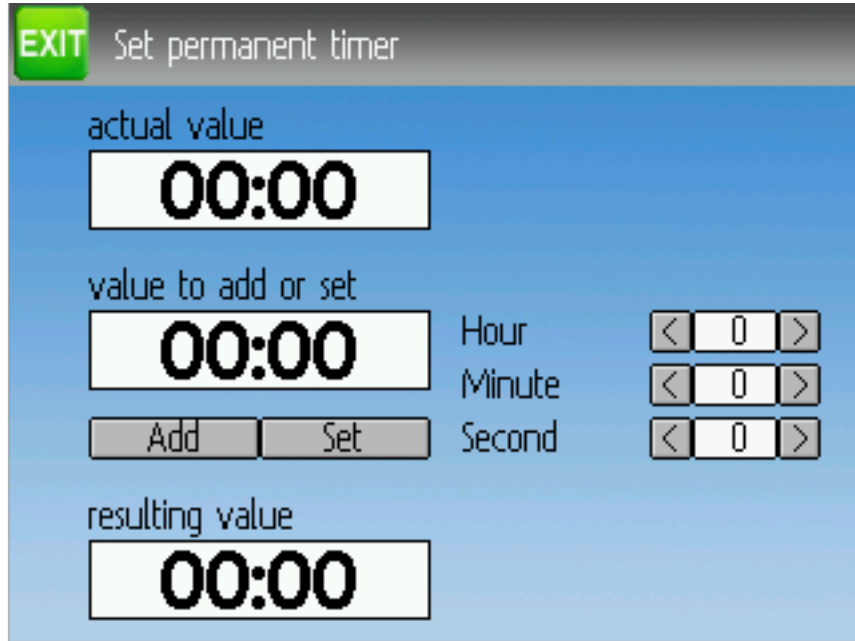

The 'permanent' timers are similar to an odometer and have their values saved in the model.ini file. They will maintain their previous value when powering up the transmitter. You can set the timer by using the 'Set to' button and reset by pressing the 'Reset' button.

8.4 Telemetry config (Std & Adv GUI)

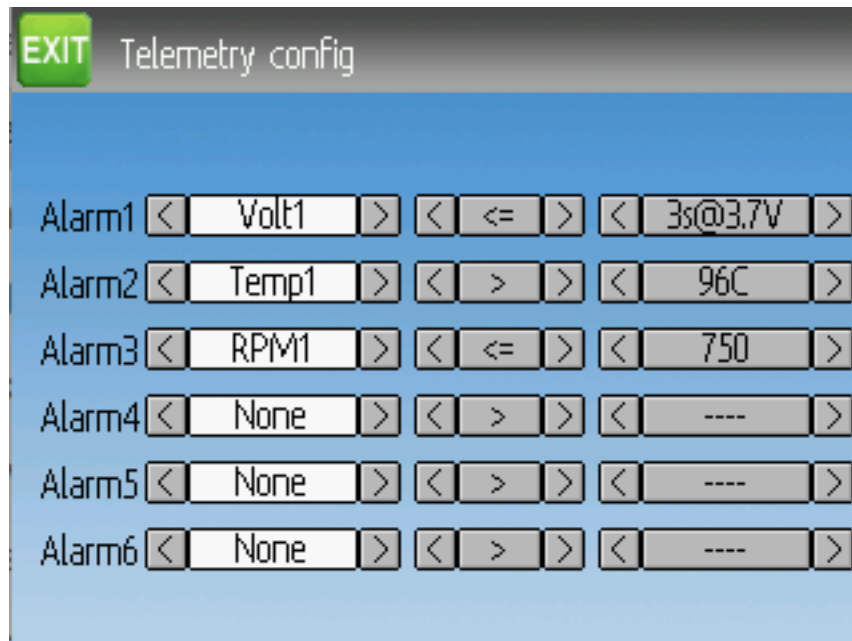

The telemetry configuration page allows specifying alarms when specific telemetry events occur.

- **Telemetry:** Specify the telemetry input to use for alarm control. The set of values available will depend on the protocol.
- **Equality:** Can be '>' or '<=' indicating whether a value above or below the target causes an alarm. Pushing the ENT button will play the alarm sound once.
- **Target:** The target value for the alarm. Additionally, by pushing the ENT button you can cycle through a time delay (between 0 and 9 seconds) for which the target value has to be continuously reached before triggering the alarm.

8.5 Trims and Virtual Inputs (Std & Adv GUI)

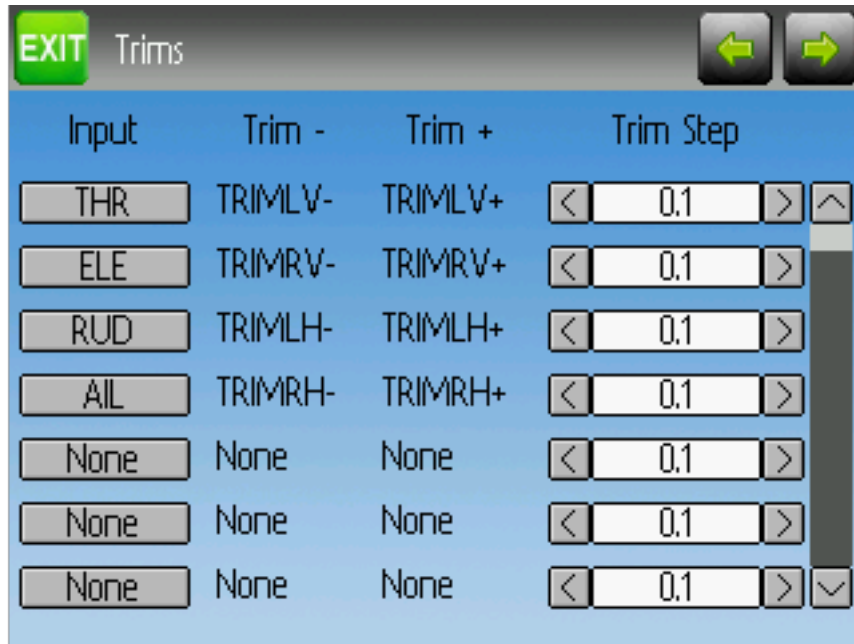

The trim page allows assigning the trim buttons and trim step, as well as configuring buttons to work as virtual inputs (see *Using a Trim as a Virtual Switch*). It is accessed from the main menu via ‘Model menu’ followed by ‘Trims’.

If the ‘Input’ field is set to an input stick, then the trim can be applied as part of the mixer, and will operate as a typical trim control. If the ‘Input’ field is set as a channel or virtual-channel output, the value is applied directly to the channel output. In this case, the selected ‘Trim +’ and ‘Trim -’ buttons can operate as a virtual stick to control an output channel.

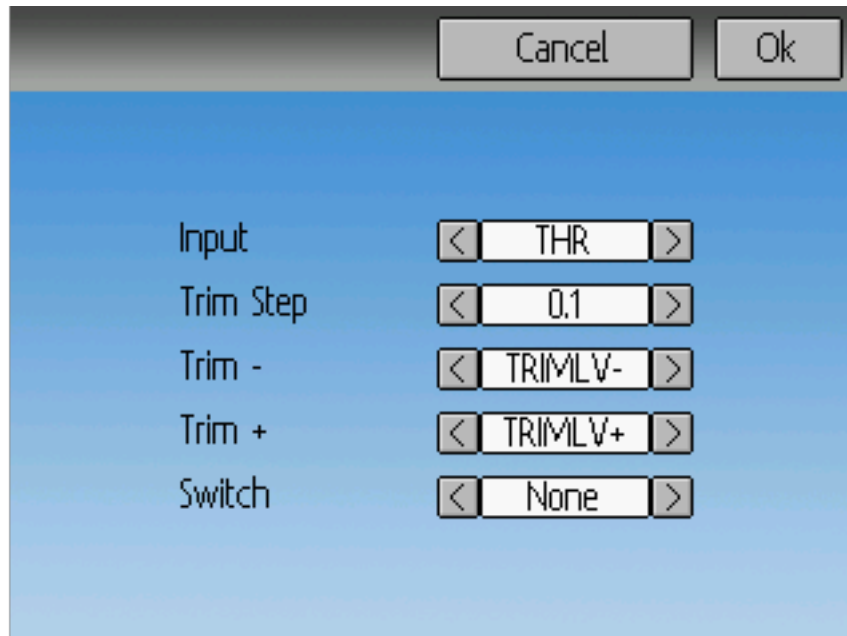

The trim-step defines how sensitive the trims are to input. The maximum number of trim steps is +/-100. So a step size of 0.1 will allow a full +/- 10% of trim adjustment on the servo.

The trim-step can be changed on the main screen. If you have to change the source also please use the dialog accessed by pressing the respective 'Input' button. Here you may also add a switch to the trim. If a switch is added to the trim, then it will have different trim values in each switch position.

8.6 Datalog (Std & Adv GUI)

The Datalog feature allows storing a history of input or output positions as well as telemetry info over a period of time. This can be used to examine and replay a flight as well as to visualize telemetry information at a later time. Logs are persistent and Deviation will continue writing to the end of the previous log by default.



- **# bytes left:** Indicates how many bytes can be written to the log before it is full.
- **Enable:** Input which enables logging.
- **Reset:** Clear the current log.
- **Rate:** How often to write current info to the log file.
- **Select:** Quickly set or reset which items are logged.
- **Controls:** Following 'Select' are a list of all controls which may be logged. They include timers, inputs, outputs, and virtual channels, and Telemetry. The more items logged the faster the log will fill up.

Logging more information By default, the log can only store 16kB of data. You can increase the amount of data to be stored by changing the datalog.bin file on the transmitter to a larger size. Deviation cannot increase the size of this file, so its size indicates the maximum data that can be stored.

Note: This is a feature for advanced users only. There is currently no software provided to analyze the logs, and they cannot be visualized from within the transmitter. Please check the downloads section on www.deviationtx.com for conversion tools.

8.7 Main page config (Std & Adv GUI)

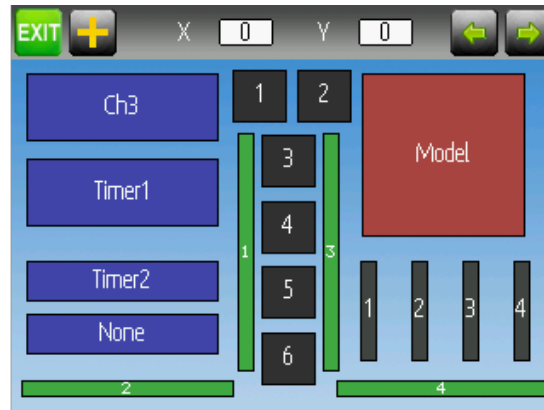

The main page config page is used to configure the main-page display. This page allows definition of which elements are shown on the main page.

The following types of objects can be displayed:

- **Box:** Display a numeric value. Values can be timers, channel values, stick inputs, etc. There are two types of boxes: big and small. The only difference is the size of the box and the text within it.
- **Trimbar:** Display a trim value. These generally are controlled by the trim switch and indicate what the current trim position is. There are two types of trims. V-Trims show a vertical bar, and H-Trims show a horizontal bar. After inserting all trims do have numbers only.
- **Model (Icon):** Display the icon related to the selected model.
- **Battery:** Display the battery voltage.
- **TxPower:** Displays the actual transmitter rating.
- **Bargraph:** Displays a vertical bar. The value of the bar is a channel output.
- **Toggle:** Show an icon indicating the state of a toggle switch. There can be 1, 2, or 3 icons defined for a given toggle indicating different states depending on the switch position. Two-state switches can have up to 2 icons. Three-state switches can have up to 3 icons.
- **(Quick) Menus:** Quick menus define quick-access pages that can be reached via a long UP/DN press.

8.7.1 Configuring object position

Each of the visual objects can be selected by pressing on them, or with the UP/DN buttons followed by ENT. Once selected, the UP/DN/L/R buttons will move the selected object on the screen. Alternatively, the X and Y spin-boxes which appear in move mode can also be used to move the selected object. Press EXT once to exit move mode.

8.7.2 Creating Objects

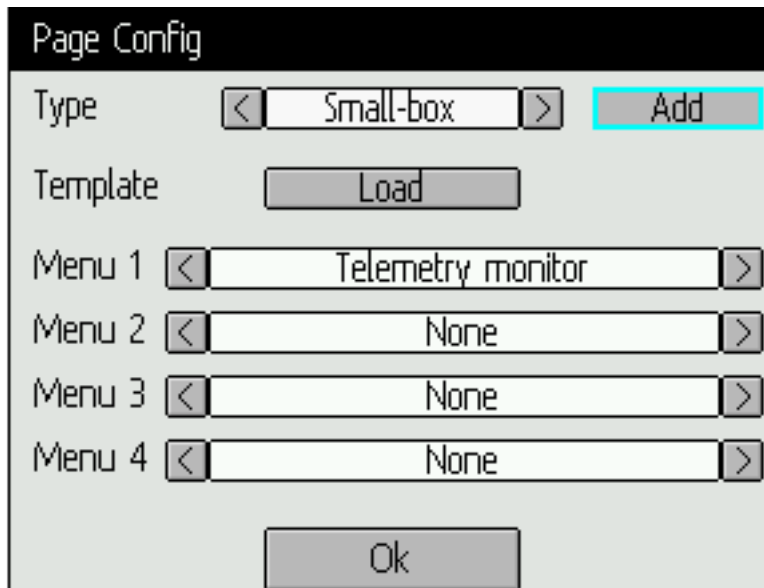

Select the '+' icon to open the add-item dialog. Then select the object type from the spin-box on the left, then press 'Add' to create the object. This will add the specified object type to the center of the screen. You can now place and configure the new object.

8.7.3 Loading Objects

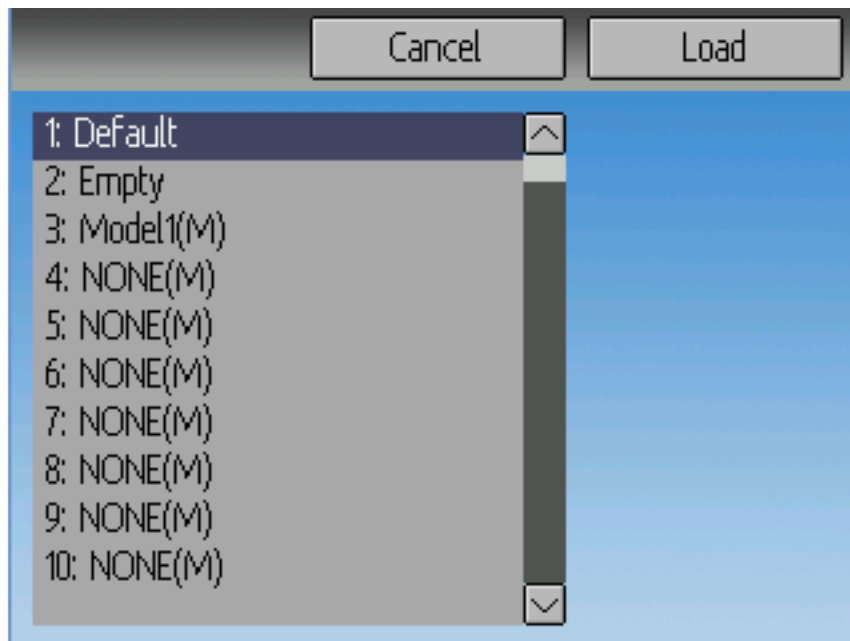

After selecting the '+' icon to open the add-item dialog, you may 'Load' alternate templates, to change the main page layout.

If you select 'Default' the layout will be set to the standard layout as shown in section *Main Page*.

Selecting ‘Empty’ will clear all objects. You may start from scratch.

If you want to use a layout from another model select the model whose layout you wish to use. The object positions (see *Configuring object position*) will be transferred when selecting from an existing template or model. Templates based on existing models have an (M) designation within the file list.

Additionally these templates can be created in the emulator or downloaded from the forums or even done by manual edit of the modelxx.ini file.

8.7.4 Configuring Objects

- **Box:** Select timer, telemetry, channel, or input from scroll-box
- **Trim:** Select trim channel from scroll-box
- **Model:** Not configurable
- **Battery:** Not configurable
- **TxPower:** Not configurable
- **Bargraph:** Select channel from scroll box
- **Toggle:** Select channel or input from scroll-box. Press related ‘Toggle’ button to choose icon
- **Menu:** Choose page to display for each of 4 quick-page slots

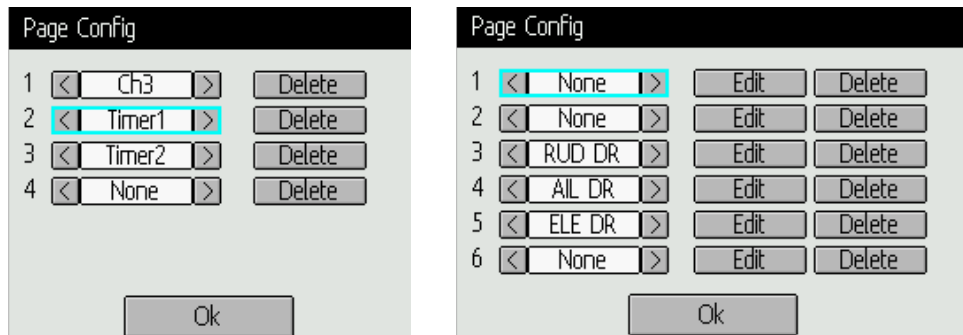

You can delete any object by configuring the object and pressing the ‘Delete’ button

8.7.5 Choosing toggle icons



















Pressing the 'Toggle' button on a toggle object allows selecting the related icons. Channels, sticks, and 2-position sticks can have 2 icons. 3 position sticks (if any) can have 3 icons. Each of the 2 (or 3) icon states can be set to empty, defining that no icon is shown for this state. The Deviation firmware comes with several predefined icons to choose from.

8.8 Standard GUI Menu items



The Standard GUI is an alternative interface from the Advanced GUI'. Which interface is used is chosen by the 'Mixer GUI' setting in section *Model setup (Std & Adv GUI)*. The Standard GUI is only available for Helicopter-type models at this time. The pages of the Standard GUI are as follows:

	Model Configuration: <i>Model setup (Std & Adv GUI)</i>		Trim configuration: <i>Trims and Virtual Inputs (Std & Adv GUI)</i>
	Servo reverse: <i>Servo Reverse</i>		Switch assignment: <i>Switch Assignment</i>
	Servo sub-trim: <i>Sub-trim Adjustment</i>		Throttle-hold configuration: <i>Throttle Hold</i>
	Servo travel-adjust: <i>Servo Travel Adjust</i>		Fail-Safe configuration: <i>Fail-Safe Configuration</i>
	Swash Setup: <i>Swash Configuration</i>		Timer configuration: <i>Timers (Std & Adv GUI)</i>
	Dual-rates setup: <i>Dual-Rate/Expo setting</i>		Telemetry configuration: <i>Telemetry config (Std & Adv GUI)</i>
	Throttle curve setup: <i>Throttle Curve</i>		Datalog configuration: <i>Datalog (Std & Adv GUI)</i>
	Pitch curve setup: <i>Pitch Curve</i>		Main page configuration: <i>Main page config (Std & Adv GUI)</i>
	Gyro-sense configuration: <i>Gyro Sensitivity</i>		

8.8.1 Servo Reverse

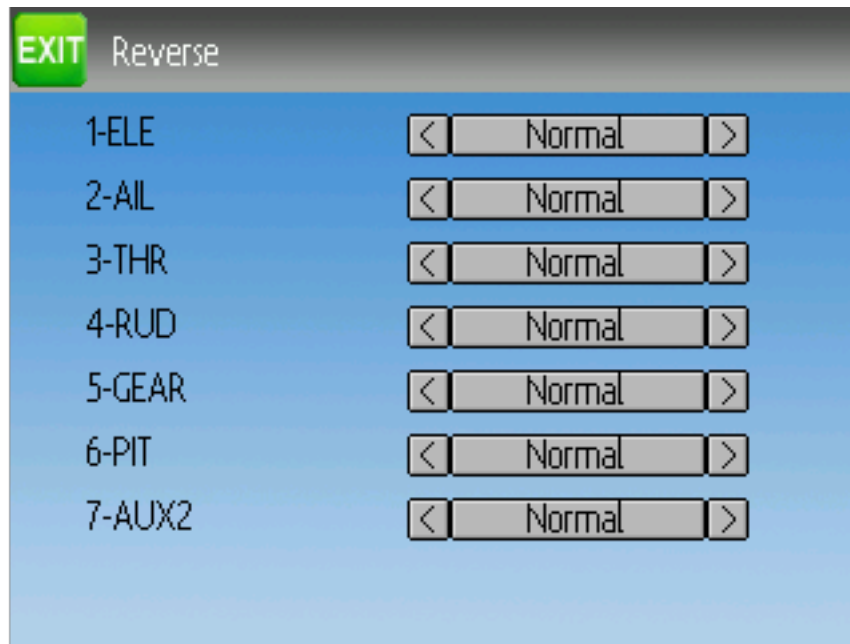

The servo reverse page allows quickly setting each channel to work in either normal or reversed mode. These settings are equivalent to the ‘Reverse’ setting on the Channel Configuration sub-page of the Mixer menu when using the Advanced GUI (see section *Channel configuration*)

8.8.2 Dual-Rate/Expo setting

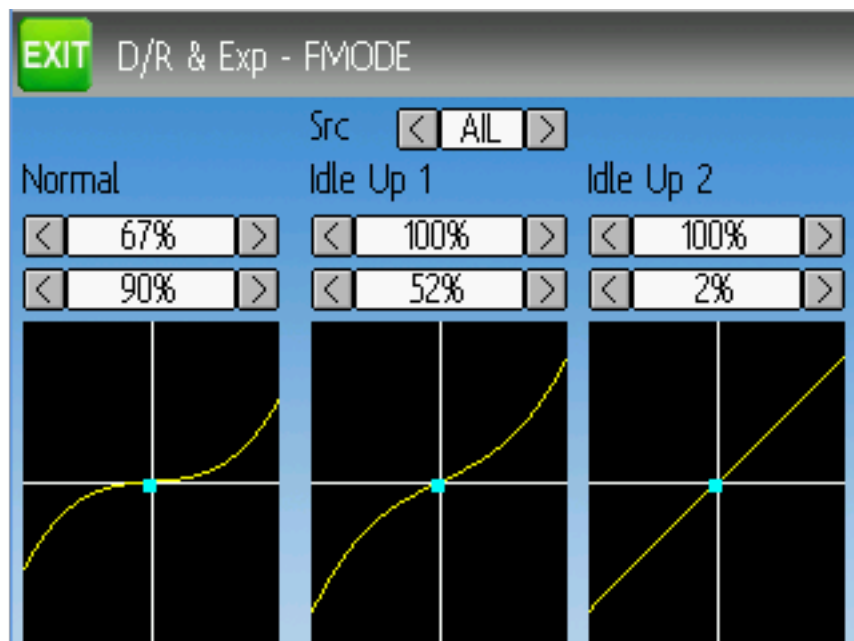

The dual-rate and expo page allows configuration of curves for the Aileron, Rudder, and Elevator channels. Up-to 3 rates can be configured for each channel, and either a scaled-linear or exponential curve can be

selected for each. The number of settings depends on the switch assigned to the dual-rates function on the Switch Assignment page (see *Switch Assignment*)

8.8.3 Sub-trim Adjustment

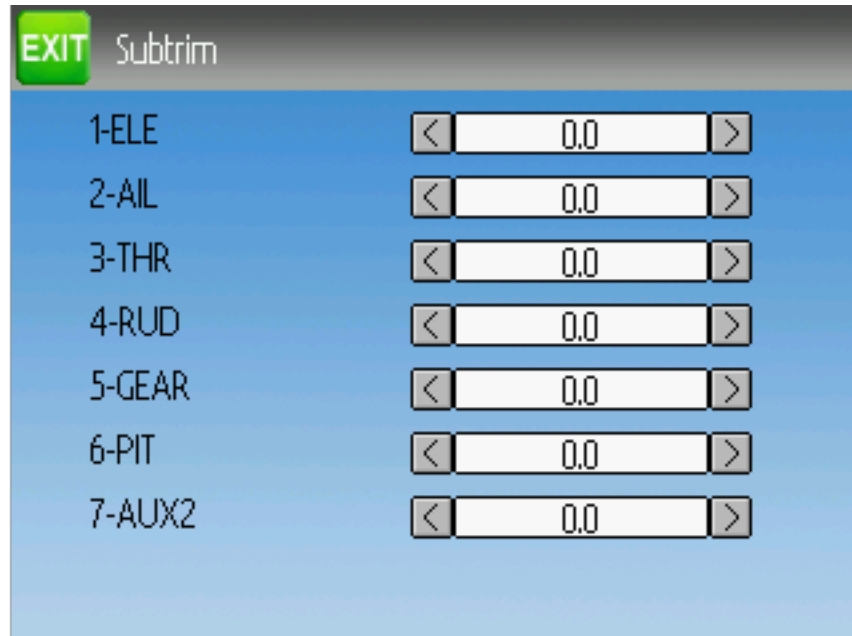

The sub-trim adjust page allows setting the zero-point of the servos for each channel. This is equivalent to the 'Subtrim' setting on the Channel Configuration sub-page of the Mixer menu when using the Advanced GUI (see *Channel configuration*). Acceptable values range from -50 to +50 in 0.1 increments.

8.8.4 Servo Travel Adjust

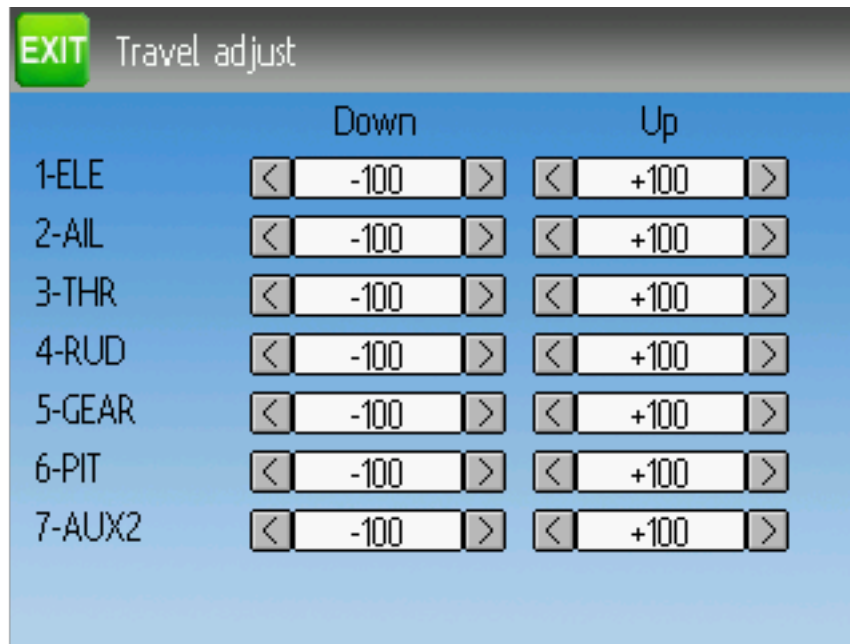

The servo-travel adjust page configures the maximum positive/negative travel of each servo. This is equivalent to the 'Scale+' and 'Scale-' settings on the Channel Configuration sub-page of the Mixer menu when using the Advanced GUI (see *Channel configuration*). Acceptable values for Down are from -175 to -1 and Up values range from +1 to +175. The default values are -100 and +100 respectively.

8.8.5 Swash Configuration

The Swash configuration page configures the swash type. More information about swash-types can be found in section *Swash Mixing*. The settings on this page are equivalent to those on the model configuration page (see *Model setup (Std & Adv GUI)*), and configuration for both pages is provided below.

Helicopter configuration from 'Model Config' page

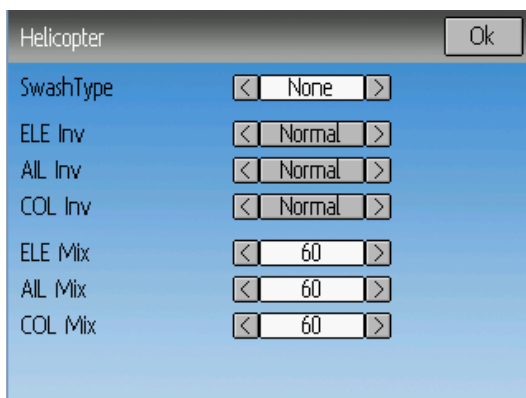

Swash configuration from Standard GUI

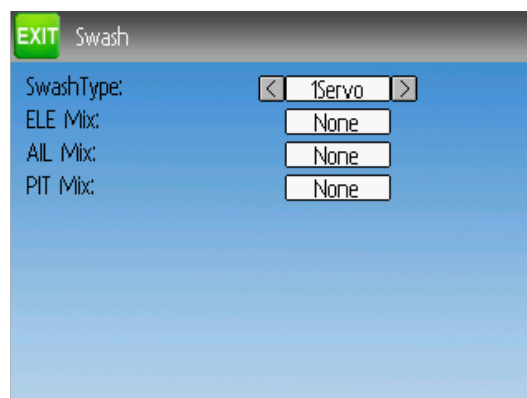

The available SwashType values are:

- **None/1Servo**: Used For FBL. Mixing occurs in receiver
- **120/3Servo 120**: 120-degree swash
- **120x/3Servo 120x**: 120 degrees swash (alternate config)
- **140/3Servo 140**: 140 degree swash
- **90/3Servo 90**: 90 degrees swash

The ELE Mix, AIL Mix, and PIT Mix are scaling factors applied to the input sticks before mixing is done. These can be used to adjust for different linkage lengths or different servo throws. The allowed range is -100 to 100 with a default of 60. Note that setting these values too large can result in too much servo throw and make the model unresponsive to stick control.

8.8.6 Throttle Curve

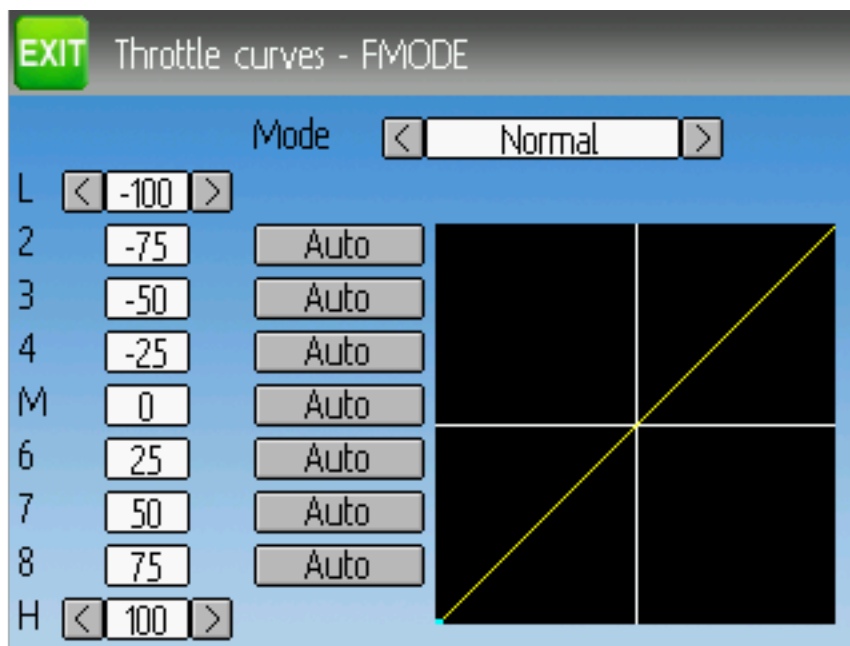

The throttle curve page allows defining a piece-wise linear curve for the throttle channel. Different curves can be selected for each flight-mode. Each point value can be enabled to be interpolated from the points surrounding it.

8.8.7 Pitch Curve

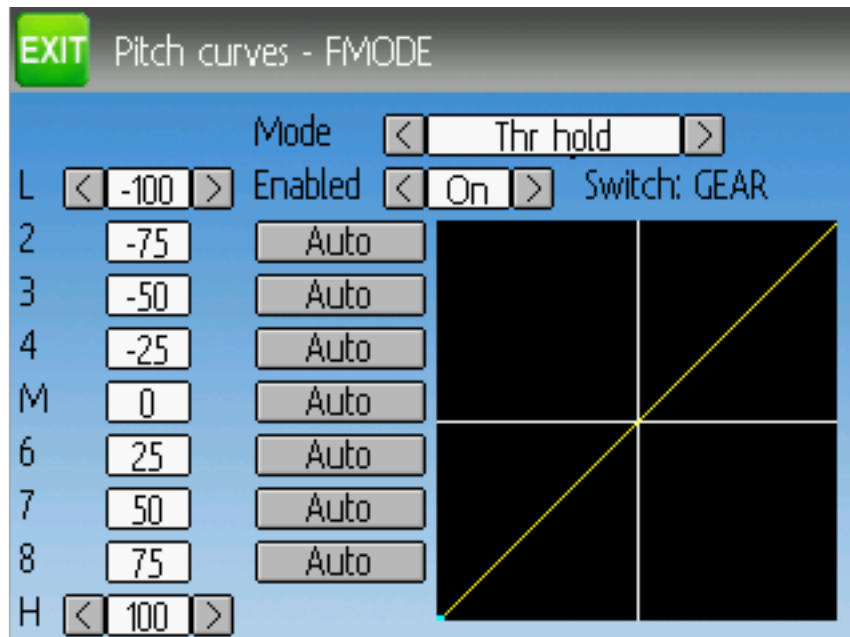

The pitch curve allows defining a piece-wise linear curve for the collective/pitch channel. Different curves can be selected for each flight-mode as well as for throttle-hold. Each point value can be enabled to be interpolated from the points surrounding it.

8.8.8 Gyro Sensitivity

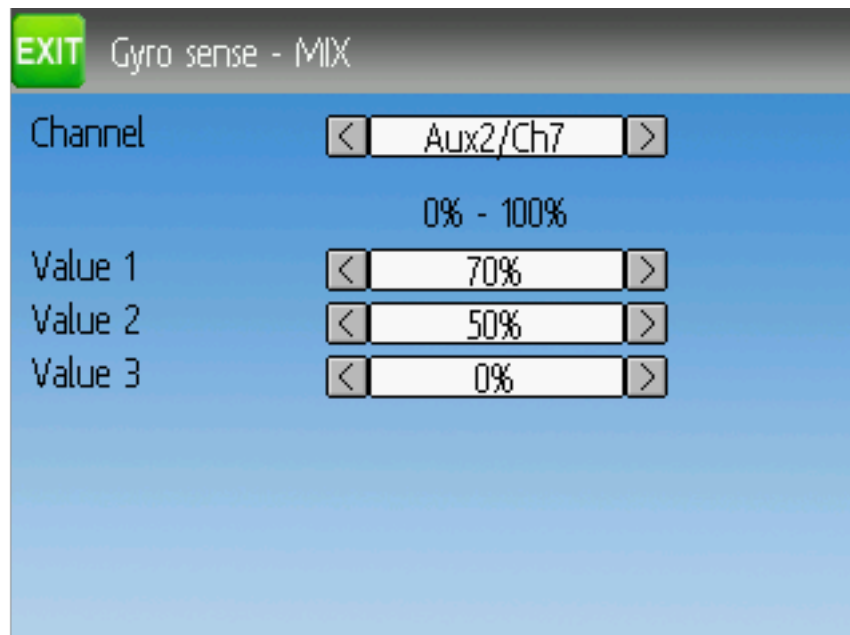

The gyro-sensitivity page enables configuring up-to 3 sensitivity values for the gyro as well as which channel to use for sending the gyro value. Acceptable values range from 0 to 100%.

8.8.9 Switch Assignment

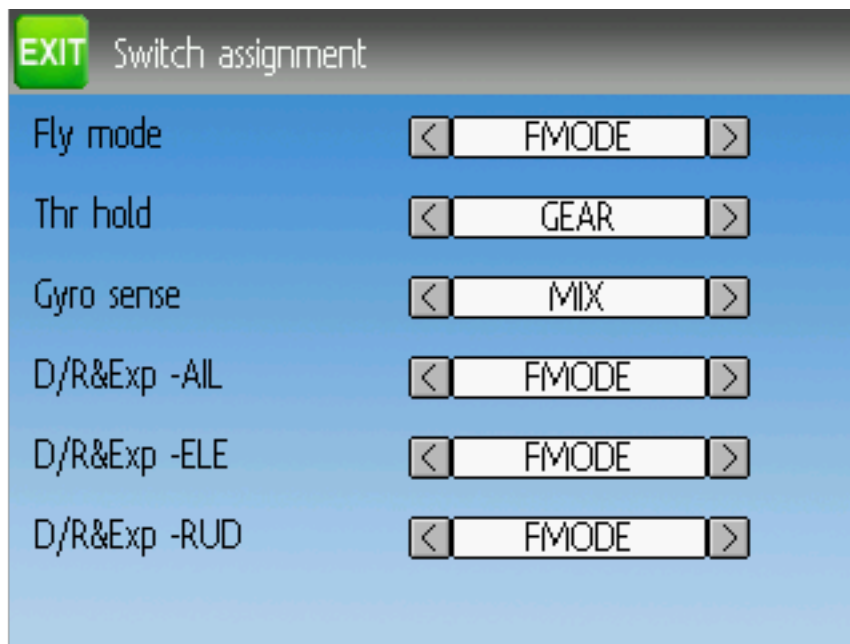

The switch assignment page enables configuring which switches to use for each capability in the standard-GUI. The same switch may be assigned to multiple capabilities.

8.8.10 Throttle Hold

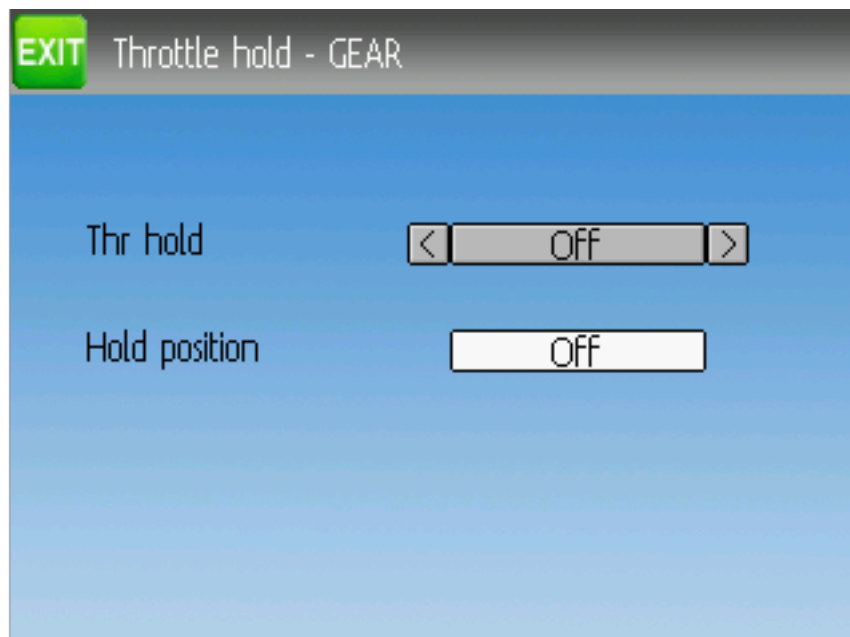

The throttle-hold page is used to enable/disable the throttle-hold capability. Specifying 'Hold position' defines the throttle value when the Throttle-hold switch is set. Hold position can be set from -200 to 200.

8.8.11 Fail-Safe Configuration

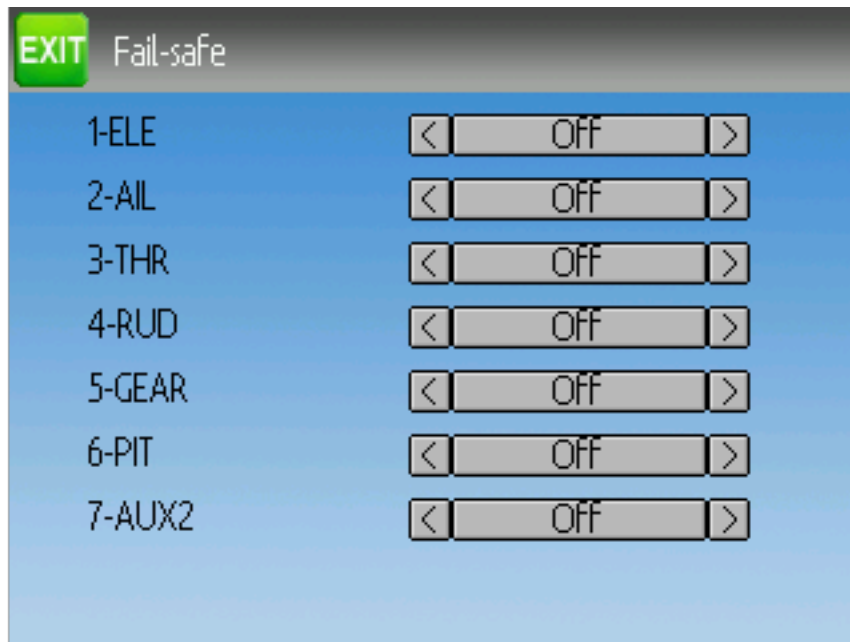

The fail-safe page is used to configure the fail-safe value for each channel (if the protocol supports this feature)

Some protocols have additional customization or limits. Each of the protocols is described below. An asterisk (*) before the protocol name in the section header means a hardware module must be added to the transmitter to support the protocol. On the transmitter display the asterisk means Deviation does not detect the required module (not installed, hardware.ini not correct, or other issue communicating with the module.) More information can be found in the Module installation guide:

http://www.deviationtx.com/wiki/#hardware_modifications

9.1 Protocol: DEVO

The DEVO protocol is used to maintain compatibility with the Walkera DEVO receivers/models. This protocol supports up to 12 channels. The DEVO protocol supports both auto-binding and manual-binding. If Fixed ID is set to 'None' the transmitter will attempt to auto-bind with the receiver every time it is powered on. If a value is set for Fixed ID, the receiver must be bound manually one-time using the 'Bind' button, after which it should stay bound. Note that the Fixed ID is only part of the binding procedure. Two transmitters with the Same ID cannot control the same model.

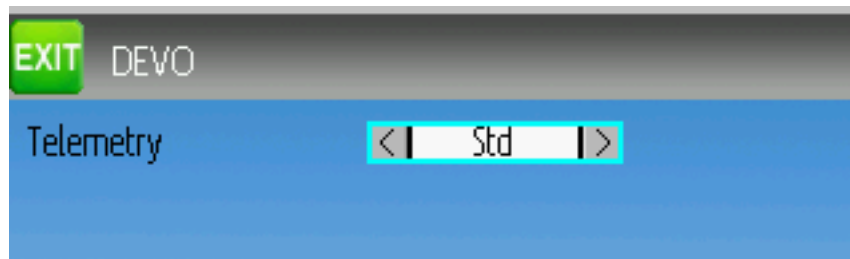

The DEVO protocol also supports enabling/disabling the telemetry capability. This option is accessed by pressing the Protocol spin-box when DEVO is shown. The options are Std (standard format), X350 (Walkera QR-X350 format), and Off.

The following fields are available in Devo Telemetry. Note that not all models/receivers report all fields, and that some fields require extra modules to enable.

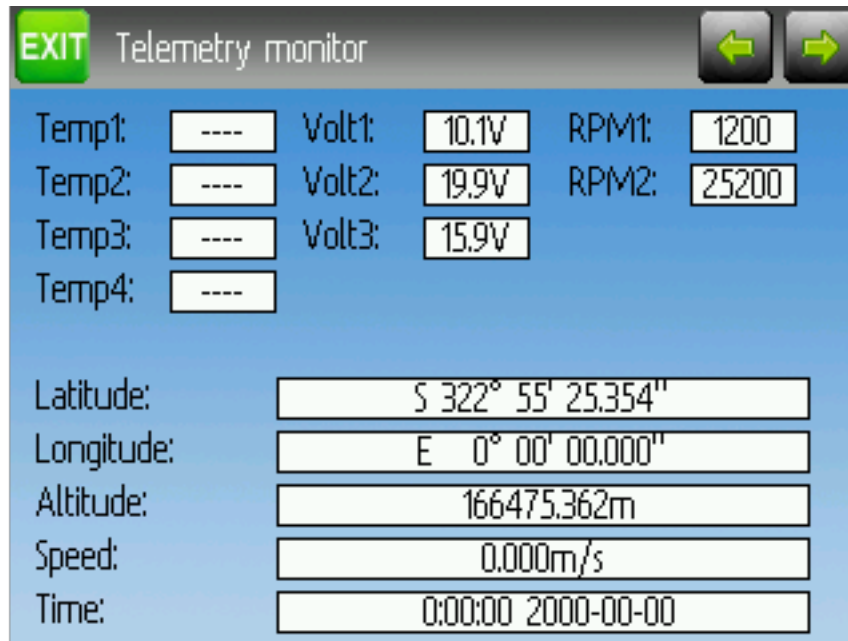

- **Temp1/2/3/4:** Temperature readings. These can be battery, motor, or ambient values
- **Volt1/2/3:** Voltage readings for receiver battery, and external batteries
- **RPM1/2:** Motor/Engine RPM values
- **GPS Data:** Current position, speed and altitude from GPS module

9.2 Protocol: WK2801

The WK2801 protocol is used to control older Walkera models. The previous Walkera models were segmented into 3 similar but not identical protocols: WK2801, WK2601, WK2401. This roughly corresponds to the number of channels supported, but many of the newer 6-channel receivers actually support the WK2801 protocol. It is recommended to try the WK2801 protocol 1st when working with older Walkera models before attempting the WK2601 or WK2401 mode, as the WK2801 is a superior protocol. The WK2801 protocol supports up to 8 channels, and both auto-binding and manual-binding. If Fixed ID is set to 'None' the transmitter will attempt to auto-bind with the receiver every time it is powered on. If a value is set for Fixed ID, the receiver must be bound manually one-time using the 'Bind' button, after which it should stay bound.

9.3 Protocol: WK2601

The WK2601 protocol is used to control older Walkera models. The previous Walkera models were segmented into 3 similar but not identical protocols: WK2801, WK2601, WK2401. This roughly corresponds to the number of channels supported, but many of the newer 6-channel receivers actually support the WK2801

protocol. It is recommended to try the WK2801 protocol 1st when working with older Walkera models before attempting the WK2601 or WK2401 mode, as the WK2801 is a superior protocol. The WK2601 protocol supports up to 7 channels, and only supports auto-binding. The fixed ID can be used, but does not prevent auto-binding during power-on.

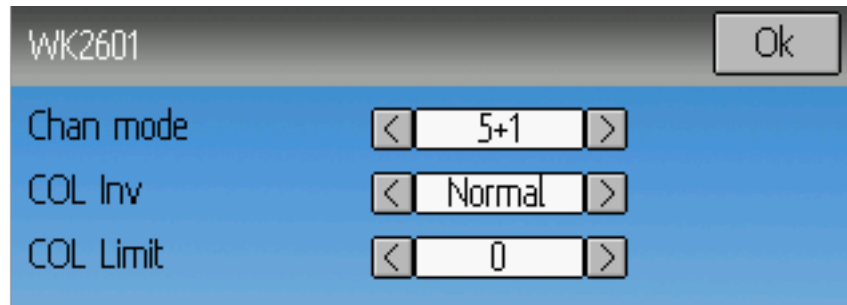

The WK2601 protocol also supports additional options. These are accessed by pressing the Protocol spin-box when Wk2601 is shown:

Chan mode: Sets how channels are processed:

- **5+1:** AIL, ELE, THR, RUD, GYRO (ch 7) are proportional. Gear (ch 5) is binary. Ch 6 is disabled
- **Heli:** AIL, ELE, THR, RUD, GYRO are proportional. Gear (ch 5) is binary. COL (ch 6) is linked to Thr. If Ch6 ≥ 0 , the receiver will apply a 3D curve to the Thr. If Ch6 < 0 , the receiver will apply normal curves to the Thr. The value of Ch6 defines the ratio of COL to THR.
- **6+1:** AIL, ELE, THR, RUD, COL (ch 6), GYRO (ch 7) are proportional. Gear (ch 5) is binary. This mode is highly experimental.
- **COL Inv:** Invert COL servo
- **COL Limit:** Set maximum range of COL servo

9.4 Protocol: WK2401

The WK2401 protocol is used to control older Walkera models. The previous Walkera models were segmented into 3 similar but not identical protocols: WK2801, WK2601, WK2401. This roughly corresponds to the number of channels supported, but many of the newer 6-channel receivers actually support the WK2801 protocol. It is recommended to try the WK2801 protocol 1st when working with older Walkera models before attempting the WK2601 or WK2401 mode, as the WK2801 is a superior protocol. The WK2401 protocol supports up to 4 channels, and only supports auto-binding. The fixed ID can be used, but does not prevent auto-binding during power-on.

9.5 Protocol: DSM2

The DSM2 protocol is used to control many Spektrum™ and JR™, as well as other models using this protocol. The DSM2 protocol can support up to 12 channels. Note that many receivers with less than 8 channels require the Transmitter to send 7 or fewer channels. Make sure the # of channels is set appropriately

for the receiver. DSM2 does not support auto-binding. If Fixed ID is set to None, a transmitter-specific ID is used instead. It is necessary to manually bind each model before the first use.

Note that binding does not exit until you move the AIL or ELE controls. This is so you can press the Failsafe button on some DSM receivers to set the failsafe value.

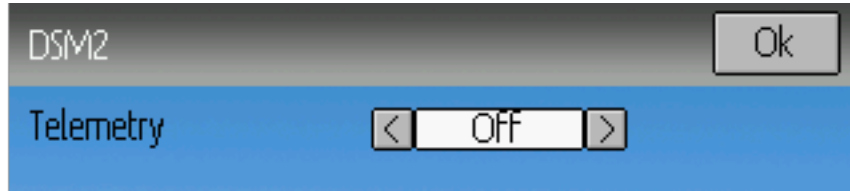

The DSM2 protocol also supports enabling/disabling the telemetry capability. This option is accessed by pressing the Protocol spin-box when DSM2 is shown.

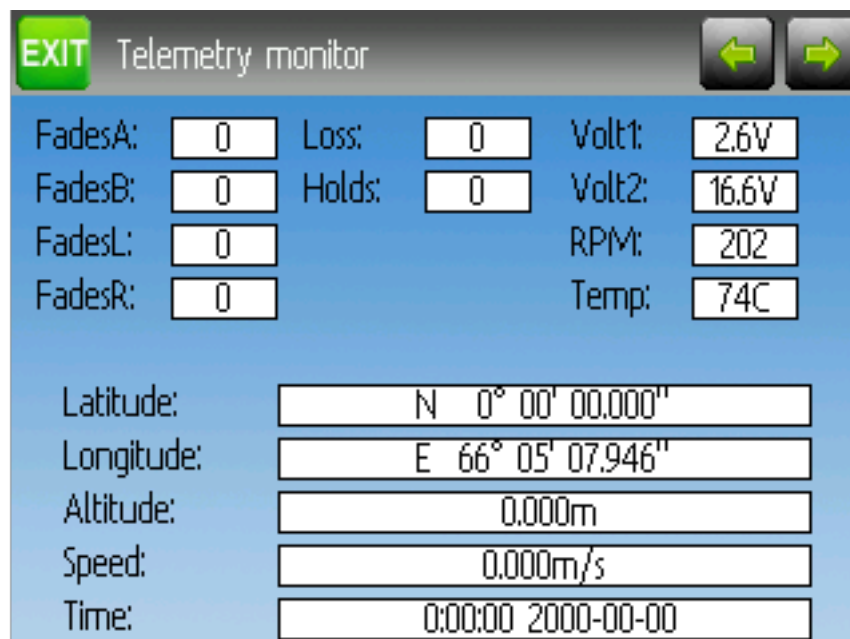

The following fields are available in DSM2 Telemetry. Note that a dedicated telemetry module and additional sensors are needed to capture this data

- **FadesA/B/L/R:** The number of times each antenna has received a weak signal. Ideally these numbers should all be similar, indicating even reception to each antenna
- **Loss:** The number of times complete signal loss (dropped frame) occurred
- **Holds:** The number of times the receiver entered fail-safe mode due to loss of signal
- **Volt1/2:** Battery voltage for receiver and an external source
- **RPM:** Engine/Motor speed
- **Temp:** Temperature from external temperature sensor
- **GPS Data:** Current position, speed and altitude from GPS module

9.6 Protocol: DSMX

The DSMX protocol is used to control many Spektrum™ and JR™, as well as other models using this protocol. The DSMX protocol can support up to 12 channels. Note that many receivers with less than 8 channels require the Transmitter to send 7 or less channels. Make sure the # of channels is set appropriately for the receiver. DSMX does not support auto-binding. If Fixed ID is set to None, a transmitter-specific ID is used instead. It is necessary to manually bind each model before the first use.

Note that binding does not exit until you move the AIL or ELE controls. This is so you can press the Failsafe button on some DSM receivers to set the failsafe value.

Note that unlike Spektrum™ or JR™ transmitters, Deviation will not automatically select between DSM2 and DSMX. The user must select which protocol to use.



The DSMX protocol also supports enabling/disabling the telemetry capability. This option is accessed by pressing the Protocol spin-box when DSMX is shown.

The list of DSMX telemetry fields is identical to those in the DSM2 Protocol, and are documented in section *Protocol: DSM2*.

9.7 Protocol: J6Pro

The J6Pro protocol is used to support Nine Eagles™ models. Only models compatible with the J6Pro transmitter can be used. Many older 4-channel Nine Eagles models used a different protocol that is unsupported. The J6Pro protocol supports up to 12 channels, although only models with 6 channels have been tested. J6Pro does not support auto-binding. If Fixed ID is set to None, a transmitter-specific ID is used instead. It is necessary to manually bind each model before the first use.

9.8 Protocol: WFLY

The WFLY protocol supports WFLY receivers such as WFR04S, WFR07S and WFR09S.

The protocol supports up to 9 channels. Default channel order is AETR.

9.9 Protocol: *Flysky

The Flysky protocol is used to control Turnigy/Flysky receivers as well as a few other models using the same AFHDS protocol (WL V911, Xieda 9958, etc). **NOTE: This protocol requires the addition of an 'A7105' hardware module to function. See the following document for more information:**

http://www.deviationtx.com/wiki/#hardware_modifications

The Flysky protocol supports up to 12 channels, and both auto-binding and manual-binding. If Fixed ID is set to 'None' the transmitter will attempt to auto-bind with the receiver every time it is powered on. If a value is set for Fixed ID, the receiver must be bound manually one-time using the 'Bind' button, after which it should stay bound.

The Flysky protocol also supports WLToys extensions to the protocol. These are accessed by pressing the Protocol spin-box when Flysky is shown:

V9x9: Enables the extensions for the WLToys V939, V949, V959, v969, etc quadcopters.

- Lights are controlled by Channel 5
- Video is controlled by Channel 6
- Camera is controlled by Channel 7
- Flip is controlled by Channel 8

V6x6: Enables the extensions for the WLToys V636 and V686 quadcopters.

- Lights are controlled by Channel 5
- Flip is controlled by Channel 6
- Camera is controlled by Channel 7
- Video is controlled by Channel 8
- Headless mode is controlled by Channel 9
- RTH mode is controlled by Channel 10
- X and Y calibration are controlled by channels 11 and 12, respectively.

V912: Enables the extensions for the V912, V913 and V915 helicopters

Note that if these channels are assigned to a switch, turning the switch on toggles the state, and turning the switch off has no effect. Thus to turn the lights on, flip the switch assigned to Channel 5 from off to on. Flipping the switch back to off has no effect. Flipping the switch back on now turns the lights back off.

9.10 Protocol: *AFHDS-2A

The AFHDS-2A protocol is used to control Turnigy/Flysky AFHDS 2A receivers. **NOTE: This protocol requires the addition of an 'A7105' hardware module to function. See the following document for more information:**

http://www.deviationtx.com/wiki/#hardware_modifications

The AFHDS-2A protocol supports up to 14 channels, and requires manual-binding. The receiver must be bound manually one-time using the 'Bind' button, after which it should stay bound.

Options configurable on the AFHDS-2A page:

- **Outputs:** Sets desired outputs type on the receiver, PWM+IBUS, PPM+IBUS, PWM+SBUS or PPM+SUBS

- **Servo Hz:** Sets receiver PWM refresh rate between 50 Hz and 400 Hz
- **LQI output:** Output LQI to an optional channel
- **Freq-fine:** Frequency offset adjustment. Range -300 to 300. Adjusts for variances between A7105 modules. Default 0. The LQI telemetry value can be used as a guide for adjusting the fine frequency protocol option.

Telemetry is supported.

9.11 Protocol: *Hubsan4

This protocol is used on the Hubsan-X4 quadcopters of the H107 series, H111, H101, H102, H201, H202 helicopters and the Estes Proto X (but not the Proto X SLT). (regular format).

This protocol is used on Hubsan H301F, H302F, H303F and H304F (H301 format)

This protocol is used on Hubsan H501S, H122D and H123D (H501 format)

NOTE: This protocol requires the addition of an ‘A7105’ hardware module to function. See the following document for more information: http://www.deviationtx.com/wiki/#hardware_modifications

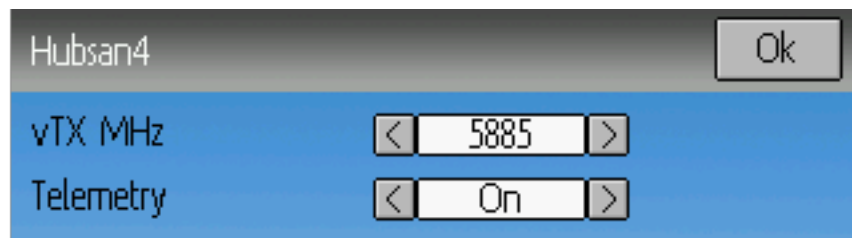

The Hubsan4 protocol supports up to 13 channels, regular format only supports auto-binding. The fixed ID can be used, but does not prevent auto-binding during power-on. The 1 st 4 channels represent Aileron, Elevator, Throttle, and Rudder. Additional channels control the quadcopter special functions:

With H301 and H501 format it is necessary to manually bind each model before the first use.

- Channel 5 Controls the LEDs
- Channel 6 Enables ‘flip’ mode or altitude hold or stabilized mode, depending on format.
- Channel 7 Turns video on/off (H102) or takes a snapshot
- Channel 8 Takes a snapshot
- Channel 9 Enables headless mode
- Channel 10 Enables return to home
- Channel 11 Enables GPS hold
- Channel 12 Sets Sport 1, Sport 2 or Acro mode (H123D)
- Channel 13 Enables ‘flip’ mode (H122D)

Options configurable on the Hubsan page:

- **vTX MHz:** Defines the frequency used by the Hubsan H107D video transmitter (Requires a 5.8GHz receiver capable of receiving and displaying video).
- **Telemetry:** Enable receiving of model battery voltage.
- **Freq-fine:** Frequency offset adjustment. Range -300 to 300. Adjusts for variances between A7105 modules. Default 0.

9.12 Protocol: *Joysway

The Joysway protocol supports the Joysway Caribbean model yacht, and the J4C12R receiver used in the Joysway Orion, Explorer, Dragon Force 65 model yachts and Force2 60 model catamaran. No other models or receivers have been tested with this protocol, including air versions of the J4C12R. **NOTE: This protocol requires the addition of an 'A7105' hardware module to function. See the following document for more information:**

http://www.deviationtx.com/wiki/#hardware_modifications

The Joysway protocol supports up to four channels, does not support auto-binding, but will bind whenever a receiver requests binding. If Fixed ID is set to None, a transmitter-specific ID is used instead. It is necessary to bind each model before the first use.

The first channel normally controls the sheets and the second channel the rudder, but this may vary from model to model.

9.13 Protocol: *Bugs3

The Bugs3 protocol is used to control MJX Bugs3 and Bugs8 aircraft. **NOTE: This protocol requires the addition of an 'A7105' hardware module to function. See the following document for more information:** http://www.deviationtx.com/wiki/#hardware_modifications

To bind first choose the bugs3 protocol and click Bind. Then apply power to the aircraft. The bind dialog will disappear if bind is successful. The aircraft's radio id is stored in the model Fixed ID field. Do not change this value.

Channels used for controlling functions. Set channel value greater than zero to activate.

- Arming is controlled by Channel 5
- Lights are controlled by Channel 6
- Flip is controlled by Channel 7
- Camera is controlled by Channel 8
- Video is controlled by Channel 9
- Angle/Acro mode is controlled by Channel 10 (>0 is Angle)

Telemetry is supported for RSSI and voltage alarm. It uses the Frsky telemetry display with signal strength reported in the RSSI field and battery voltage in VOLT1. The bugs3 receiver only reports good/bad voltage. This is translated to VOLT1 values of 8.4V for good and 6.0V for low voltage.

9.14 Protocol: *Frsky-V8

The Frsky-V8 protocol is used to control older Frsky™ receivers using the one-way protocol. **NOTE: This protocol requires the addition of an ‘CC2500’ hardware module to function. See the following document for more information:**

http://www.deviationtx.com/wiki/#hardware_modifications

The Frsky-V8 protocol supports 8 channels, does not support auto-binding. If Fixed ID is set to None, a transmitter-specific ID is used instead. It is necessary to manually bind each model before the first use.

9.15 Protocol: *Frsky

The Frsky protocol is used to control newer (telemetry enabled) Frsky™ receivers using the two-way protocol (D8). **NOTE: This protocol requires the addition of an ‘CC2500’ hardware module to function. See the following document for more information:**

http://www.deviationtx.com/wiki/#hardware_modifications

The Frsky protocol supports up to 8 channels, does not support auto-binding. If Fixed ID is set to None, a transmitter-specific ID is used instead. It is necessary to manually bind each model before the first use.

The Frsky protocol also supports enabling/disabling telemetry. This option is accessed by pressing the Protocol spin-box when Frsky is shown.

When telemetry is enabled the values sent by the receiver (RSSI, VOLT1, VOLT2) are supported.

Additional Hub telemetry values are supported in common with the FrskyX protocol on transmitters except the 7e and f7. See the Frsky Telemetry section below.

9.16 Protocol: *FrskyX

The FrskyX protocol implements the Frsky D16 radio protocol, including S.Port and hub telemetry.

NOTE: This protocol requires the addition of an ‘CC2500’ hardware module to function. See the following document for more information: http://www.deviationtx.com/wiki/#hardware_modifications

This protocol supports up to 16 channels. Fixed ID binding is supported to link the transmitter with specific receivers. Supports receiver telemetry (RSSI, VOLT1) on all transmitters. Supports S.Port and hub telemetry sensors as well as GPS telemetry (except on memory-limited 7e and f-series) as described in the next section.

The following protocol options are available.

Freq-fine: Frequency offset adjustment. Range -127 to 127. Adjusts for variances between CC2500 modules. Usually offset of 0 or -41 is required, but full range should be tested if there are problems with binding or range. Default 0. The LQI telemetry value can be used as a guide for adjusting the fine frequency protocol option.

AD2GAIN: The VOLT2 telemetry value (AIN input on X4R) is multiplied by this value divided by 100. Allows adjustment for external resistor divider network. Default 100 (gain of 1). Range is 1 to 2000 (gain of 0.01 to 20.00).

Failsafe: The Frsky failsafe options are fully supported. If the channel failsafe (in mixer channel config) is set this value is sent to the receiver every 9 seconds. The receiver will use these values in failsafe mode unless the protocol option is set to RX.

Format: Set the format to match the firmware in the receiver. Both FCC and EU. The EU version is compatible with the Frsky LBT firmware, but does not actually perform the LBT test.

RSSIChan: When set to LastChan the received RSSI will be transmitted on the last radio channel. The last channel is based on the # of Channels setting in the model. The channel value is the received RSSI value multiplied by 21.

S.Port Out: When enabled received s.port packets are echoed to the trainer port and extended voice is disabled.

Bind Mode: The bind mode will control which channels will be connected to the receiver PWM outputs and allow to enable or disable the receivers telemetry during bind.

Version: This will switch between FrSkyX V1.x.x and V2.1.x protocol version.

For channels with failsafe set to off, the default Failsafe protocol option “Hold” commands the receiver to hold the last received channel values when the receiver enters failsafe mode. The “NoPulse” setting causes the receiver to not send any signal on PPM outputs (Testing on X8R showed SBUS values went to minimum, but SBUS behavior is not specified by the protocol). The “RX” setting prevents Deviation from sending failsafe settings so the receiver will use whatever failsafe values have been stored in the receiver.

When S.Port Out is enabled and PPMIn is not used, received S.Port packets are sent out the trainer port. The bit rate is 57600 for compatibility with S.Port decoders, but the signal must be inverted to connect to a standard decoder. It can be connected directly to the input of a 3.3V ftdi adapter.

9.17 *Frsky and FrskyX Extended Telemetry*

Extended telemetry refers to the hub and S.Port Frsky telemetry sensors. These sensors are supported in all transmitters except the 7e. They are available on the telemetry test pages and main page boxes.

The FrskyX S.Port telemetry provides for connecting up to 16 sensors of the same type (e.g. battery voltage). Deviation supports multiple sensors of the same type, but only one telemetry value is saved. The value most recently received from all the sensors of the same type is reported.

Telemetry values are reset on long press of the Up button while displaying the telemetry monitor page. For Frsky telemetry this resets the vario altitude “ground level” to the next received telemetry value, which zeroes the vario altitude telemetry value. It also resets the battery discharge accumulator and minimum cell voltage. The ground level value is saved in the model file to save the setting through power cycles - the value is fairly constant during a single day of flying in stable air.

Telemetry test page

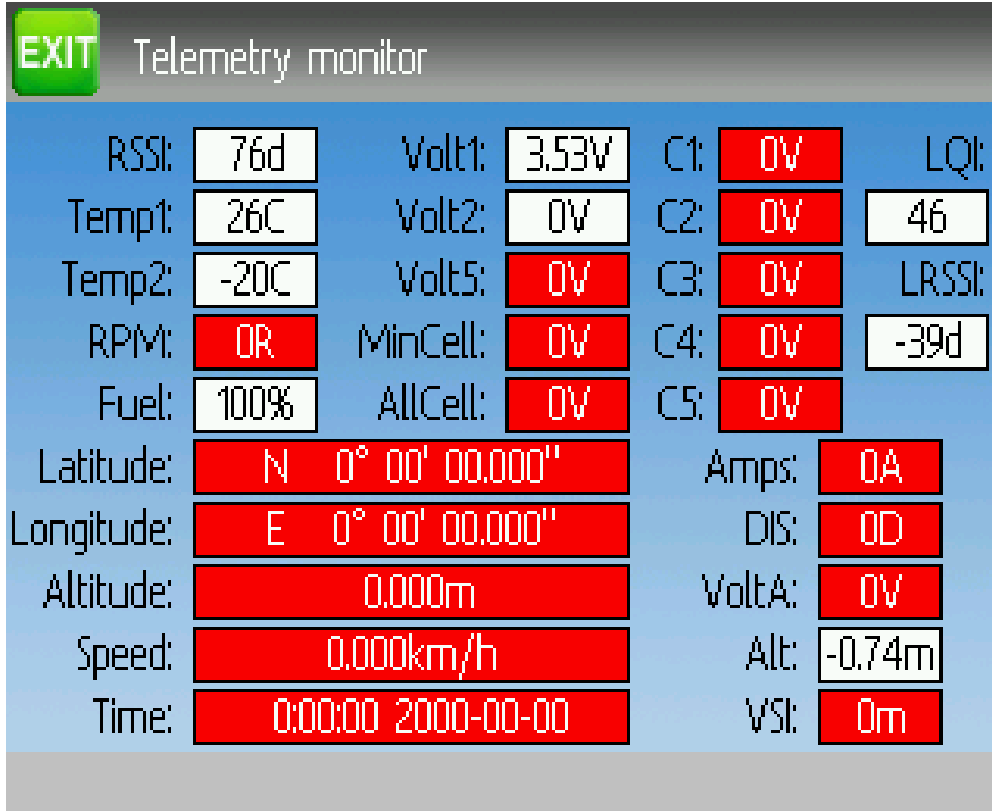

The CELL voltages are labeled C1-C5.

The ALTITUDE value is reported as Above Ground Level. The ground level is set to the first altitude telemetry value received.

The LQI (Link Quality Indicator) and LRSSI (Local RSSI) indicate the quality and signal strength of the telemetry signal from the receiver. The LQI can be used as a guide for adjusting the fine frequency protocol option. Lower LQI is better and values under 50 are typical. The LRSSI units is (approximately) dBm.

Derived values: MINCELL is the lowest reported CELL value. ALLCELL is the total of all reported CELL values. Discharge is total battery discharge amount in milliAmp-hours.

9.18 Protocol: *Skyartec

The Skyartec protocol is used to control Skyartec™ receivers and models. **NOTE: This protocol requires the addition of an ‘CC2500’ hardware module to function. See the following document for more information:**

http://www.deviationtx.com/wiki/#hardware_modifications

The Skyartec protocol supports up to 7 channels, does not support auto-binding. If Fixed ID is set to None, a transmitter-specific ID is used instead. It is necessary to manually bind each model before the first use.

9.19 Protocol: *Futaba S-FHSS

The Futaba S-FHSS protocol is used to control Futaba™ receivers and models. It also used by some models of XK Innovations and has third party compatible receivers available. **NOTE: This protocol requires the addition of an ‘CC2500’ hardware module to function. See the following document for more information:**

http://www.deviationtx.com/wiki/#hardware_modifications

The S-FHSS protocol supports up to 8 channels, and only supports auto-binding. If Fixed ID is set to None, a transmitter-specific ID is used instead. It is necessary to manually bind each model before the first use.

Traditional Futaba channel layout is following: Aileron, Elevator, Throttle, Rudder, Gear, Pitch, Aux1, and Aux2. So it is suitable for control of Collective Pitch (CP) helicopters.

Protocol resolution is 1024 steps (10 bits) out of which a bit smaller range is actually used (data by reverse engineering using third party equipment). Temporal resolution is 6.8ms. No telemetry supported.

9.20 Protocol: *Corona

The Corona protocol supports Corona V1 and V2 receivers, and Flydream V3 receivers. **NOTE: This protocol requires the addition of an ‘CC2500’ hardware module to function. See the following document for more information:** http://www.deviationtx.com/wiki/#hardware_modifications

All the protocols support up to 8 channels. Default channel order is AETR. No telemetry in the protocols.

The following protocol options are available.

Format: Protocol selection. Use V1 and V2 with Corona receivers. Use FDV3 for Flydream V3.

Freq-fine: Frequency offset adjustment. Range -127 to 127. Adjusts for variances between CC2500 modules. Usually offset of 0 or -41 is required, but full range should be tested if there are problems with binding or range. Default 0.

9.21 Protocol: *Hitec

The Hitec protocol supports Optima and Minima receivers. **NOTE: This protocol requires the addition of an ‘CC2500’ hardware module to function. See the following document for more information:** http://www.deviationtx.com/wiki/#hardware_modifications

The protocol supports up to 9 channels. Default channel order is AETR. Telemetry is supported using the Frsky telemetry layout. The following values are supported: VOLT1, VOLT2, CURRENT, TEMP1, TEMP2, FUEL, RPM, LRSSI, LQI, and GPS (latitude, longitude, altitude, speed, heading). Receiver RSSI is not available in this protocol.

The following protocol options are available.

Format: Receiver selection for Optima or Minima.

Freq-fine: Frequency offset adjustment. Range -127 to 127. Adjusts for variances between CC2500 modules. Usually offset of 0 or -41 is required, but full range should be tested if there are problems with binding or range. Default 0.

9.22 Protocol: *V202

The V202 protocol supports the WLToys V202 quadcopter. **NOTE: This protocol requires the addition of an ‘NRF24L01’ hardware module to function. See the following document for more information:**

http://www.deviationtx.com/wiki/#hardware_modifications

The V202 protocol supports up to 12 channels, does not support auto-binding. If Fixed ID is set to None, a transmitter-specific ID is used instead. It is necessary to manually bind each model before the first use.

The 1 st 4 channels represent Aileron, Elevator, Throttle, and Rudder. Additional channels control the quadcopter special functions:

- Channel 5 controls the blink speed
- Channel 6 enables ‘flip’ mode
- Channel 7 takes still pictures
- Channel 8 turns video on/off
- Channel 9 turns headless mode on/off
- Channel 10 causes the x axis to calibrate
- Channel 11 causes the y axis to calibrate

If JXD-506 format is selected, channels 10-12 are used for:

- Channel 10 start/stop
- Channel 11 emergency stop
- Channel 12 gimbal control

Also, models compatible with this format require the throttle stick to be centered before arming.

9.23 Protocol: *SLT

The SLT protocol is used to control TacticSLT/Anylink receivers. **NOTE: This protocol requires the addition of an ‘NRF24L01’ hardware module to function. See the following document for more information:**

http://www.deviationtx.com/wiki/#hardware_modifications

The SLT protocol supports up to 6 channels, and only supports auto-binding. The fixed ID can be used, but does not prevent auto-binding during power-on.

9.24 Protocol: *HiSky

The HiSky protocol is used to control HiSky brand models along with the WLToys v922 v955 models. **NOTE: This protocol requires the addition of an ‘NRF24L01’ hardware module to function. See the following document for more information:**

http://www.deviationtx.com/wiki/#hardware_modifications

The HiSky protocol supports up to 7 channels, does not support auto-binding. If Fixed ID is set to None, a transmitter-specific ID is used instead. It is necessary to manually bind each model before the first use.

9.25 Protocol: *YD717

The YD717 protocol supports the YD717 and Skybotz UFO Mini quadcopters, plus several models from Sky Walker, XinXun, Ni Hui”), and Syma through protocol options. See the Supported Modules spreadsheet for a complete list. **NOTE: This protocol requires the addition of an ‘NRF24L01’ hardware module to function. See the following document for more information:**

http://www.deviationtx.com/wiki/#hardware_modifications

The YD717 protocol supports 9 channels and only supports auto-binding. The protocol stays in bind mode until successful.

The first four channels represent Aileron, Elevator, Throttle, and Rudder.

The fifth channel enables the auto-flip function when greater than zero. Additionally to enable auto-flips left and right the aileron channel scale must be 87 or greater. Likewise for the elevator channel and front/back flips. When auto-flip is enabled, moving the cyclic all the way in any direction initiates a flip in that direction. The YD717 requires at least four seconds between each auto-flip.

The sixth channel turns on lights when greater than zero.

The seventh channel takes a picture on transition from negative to positive.

The eighth channel starts/stops video recording on each positive transition.

The ninth channel is assigned to last feature flag available in the protocol. This may control headless mode on models that have the feature.

9.26 Protocol: *SymaX

This protocol is used on Syma models: X5C-1, X11, X11C, X12, new X4, and new X6. A variant supporting the original X5C and the X2 is included as a protocol option. (The Syma X3, old X4, and old X6 are supported with the SymaX4 option in the YD717 protocol.) See the Supported Modules spreadsheet for a complete list. **NOTE: This protocol requires the addition of an ‘NRF24L01+’ hardware module to function. Note the “plus” version of the nRF device is required to support the 250kbits/s data rate. See the following document for more information:**

http://www.deviationtx.com/wiki/#hardware_modifications

The SymaX protocol supports 9 channels and only supports auto-binding.

The first four channels represent Aileron, Elevator, Throttle, and Rudder.

The fifth channel is unused.

The sixth channel enables the auto-flip function when greater than zero.

The seventh channel takes a picture when the channel moves from negative to positive.

The eighth channel starts/stops video recording on each positive transition.

The ninth channel enables headless mode when positive.

9.27 Protocol: *Hontai

This protocol is used on Hontai models F801 and F803.

NOTE: This protocol requires the addition of an ‘NRF24L01+’ hardware module to function. Note the “plus” version of the nRF device is required to support the 250kbits/s data rate. See the following document for more information: http://www.deviationtx.com/wiki/#hardware_modifications

The first four channels represent Aileron, Elevator, Throttle, and Rudder. Additional channels control special functions:

- Channel 5 is unused
- Channel 6 enables the flip function
- Channel 7 takes a picture on positive transition through zero
- Channel 8 turns video on/off on positive transition
- Channel 9 turns headless mode on/off
- Channel 10 engages the return-to-home feature
- Channel 11 initiates calibration

9.28 Protocol: *Bayang

This protocol is used on BayangToys X6, X7, X8, X9, X16, Boldclash B03, JJRC/Eachine E011, H8, H9D v2, H10, Floureon H101, JJRC JJ850, JFH H601, and H606 (regular format).

This protocol is used on BayangToys X16 with altitude hold (X16-AH format).

This protocol is used on IRDRONE Ghost X5 (IRDRONE format).

NOTE: This protocol requires the addition of an ‘NRF24L01+’ hardware module to function. Note the “plus” version of the nRF device is required to support the 250kbits/s data rate. See the following document for more information: http://www.deviationtx.com/wiki/#hardware_modifications

The first four channels represent Aileron, Elevator, Throttle, and Rudder. Additional channels control special functions:

- Channel 5 activates LEDs or inverted flight (Floureon H101)
- Channel 6 enables the flip function
- Channel 7 captures single photo on positive transition
- Channel 8 starts/stops video recording on positive transition
- Channel 9 turns headless mode on/off
- Channel 10 engages the return-to-home feature
- Channel 11 enables Take Off/Landing
- Channel 12 activates emergency stop
- Channel 13 analog aux channel #1
- Channel 14 analog aux channel #2

NOTE: Channels 13 and 14 are only active when using NFE Silverware firmware (and some other Silverware forks). Two otherwise static bytes in the protocol overridden to add two ‘analog’ (non-binary) auxiliary channels. The “Analog Aux” Bayang protocol option must be enabled on the TX and the Silverware firmware must have the Analog Aux feature enabled. Mismatches between TX and RX settings will prevent binding.

9.29 Protocol: *FY326

This protocol is used on FY326 red board.

NOTE: This protocol requires the addition of an ‘NRF24L01+’ hardware module to function. Note the “plus” version of the nRF device is required to support the 250kbits/s data rate. See the following document for more information: http://www.deviationtx.com/wiki/#hardware_modifications

The first four channels represent Aileron, Elevator, Throttle, and Rudder. Additional channels control special functions:

- Channel 5 is unused
- Channel 6 enables the flip function
- Channel 7 is unused
- Channel 8 is unused
- Channel 9 turns headless mode on/off
- Channel 10 engages the return-to-home feature
- Channel 11 initiates calibration

9.30 Protocol: *CFlie

The CFlie protocol is used on the CrazyFlie nano quad. It has not been tested with any other models. **NOTE: This protocol requires the addition of an ‘NRF24L01+’ hardware module to function. Note the “plus” version of the nRF device is required to support the 250kbits/s data rate. See the following document for more information:**

http://www.deviationtx.com/wiki/#hardware_modifications

The CFlie protocol supports up to 4 channels, does not support auto-binding. If Fixed ID is set to None, a transmitter-specific ID is used instead. It is necessary to manually bind each model before the first use.

9.31 Protocol: *H377

The H377 protocol supports the NiHui H377 6 channel helicopter. It has not been tested with any other models. **NOTE: This protocol requires the addition of an ‘NRF24L01’ hardware module to function. See the following document for more information:**

http://www.deviationtx.com/wiki/#hardware_modifications

The H377 protocol supports up to 7 channels, does not support auto-binding. If Fixed ID is set to None, a transmitter-specific ID is used instead. It is necessary to manually bind each model before the first use.

9.32 Protocol: *HM830

The HM830 protocol supports the HM830 Folding A4 Paper airplane. It has not been tested with any other models. **NOTE: This protocol requires the addition of an ‘NRF24L01’ hardware module to function. See the following document for more information:**

http://www.deviationtx.com/wiki/#hardware_modifications

The HM830 protocol supports 5 channels and only supports auto-binding. The protocol stays in bind mode until successful.

9.33 Protocol: *KN

The KN protocol is used on the WLToys V930, V931, V966, V977 and V988 (WLToys format) as well as the Feilun FX067C, FX070C and FX071C (Feilun format) helicopters. It has not been tested with other models. **NOTE: This protocol requires the addition of an ‘NRF24L01+’ hardware module to function. Note the “plus” version of the nRF device is required to support the 250kbits/s data rate. See the following document for more information:**

http://www.deviationtx.com/wiki/#hardware_modifications

The KN protocol supports up to 11 channels and does not support auto-binding. If Fixed ID is set to None, a transmitter-specific ID is used instead. It is necessary to manually bind each model before the first use.

Channels 1-4 are throttle, aileron, elevator and rudder. Channel 5 activates the model's built-in dual rate. Channel 6 activates throttle hold. Channel 7 activates idle up (WL Toys V931, V966 and V977 only). Channel 8 toggles between 6G (default) and 3G stabilization. Channel 9-11 are trim channels for throttle/pitch, elevator and rudder.

9.34 Protocol: *ESky150

The ESKy150 protocol supports the smaller ESKy models from 2014 onwards (150, 300, 150X). It has not been tested with any other models. **NOTE: This protocol requires the addition of an 'NRF24L01' hardware module to function. See the following document for more information:**

http://www.deviationtx.com/wiki/#hardware_modifications

The Esky150 protocol supports up to 7 channels, and does not support auto-binding. If Fixed ID is set to None, a transmitter-specific ID is used instead. It is necessary to manually bind each model before the first use.

Channels 1-4 are throttle, aileron, elevator and rudder. Channel 5 is flight mode (1 bit switch with only two states). Channel 6 is not yet used on any of the tested models. Channel 7 is a 2 bit switch (4 states).

It is important if you have a 4 channel model, to configure that your model only has 4 channels, otherwise the throttle values can go crazy.

9.35 Protocol: *Esky

Needs to be completed. **NOTE: This protocol requires the addition of an 'NRF24L01' hardware module to function. See the following document for more information:**

http://www.deviationtx.com/wiki/#hardware_modifications

The Esky protocol supports up to 6 channels, does not support auto-binding. If Fixed ID is set to None, a transmitter-specific ID is used instead. It is necessary to manually bind each model before the first use.

9.36 Protocol: *BlueFly

The BlueFly protocol is used with the Blue-Fly HP100. It has not been tested with any other models. **NOTE: This protocol requires the addition of an 'NRF24L01+' hardware module to function. Note the "plus" version of the nRF device is required to support the 250kbits/s data rate. See the following document for more information:**

http://www.deviationtx.com/wiki/#hardware_modifications

The BlueFly protocol supports up to 6 channels, does not support auto-binding. If Fixed ID is set to None, a transmitter-specific ID is used instead. It is necessary to manually bind each model before the first use.

9.37 Protocol: *CX10

The CX10 format supports the Cheerson CX10 quadcopter. **NOTE: This protocol requires the addition of an ‘NRF24L01’ hardware module to function. See the following document for more information:**

http://www.deviationtx.com/wiki/#hardware_modifications

The CX10 protocol supports 9 channels and only supports auto-binding. The protocol stays in bind mode until successful. The first four channels are Aileron, Elevator, Throttle and Rudder.

Channel 5 is Rate except on the CX-10A, where it is headless mode.

Channel 6 is flip mode.

The DM007 format also uses channel 7 for the still camera, channel 8 for the video camera and channel 9 for headless mode.

The protocol has a Format option for the Blue-A, Green, DM007, Q282, JC3015-1, JC3015-2, MK33041 and Q242 quadcopters.

9.38 Protocol: *CG023

The CG023 protocol supports the Eachine CG023 and 3D X4 quadcopters. It has not been tested on other models. **NOTE: This protocol requires the addition of an ‘NRF24L01’ hardware module to function. See the following document for more information:**

http://www.deviationtx.com/wiki/#hardware_modifications

The CG023 protocol supports 9 channels and only supports auto-binding.

The first four channels are Aileron, Elevator, Throttle and Rudder.

Channel 5 controls the LEDs.

Channel 6 controls Flip mode.

Channel 7 controls the still camera

Channel 8 controls the video camera.

Channel 9 controls headless mode.

The protocol has a Format option for the YD829 quadcopter.

9.39 Protocol: *H8_3D

The H8_3D protocol supports the Eachine H8 3D, JJRC H20 and H11D quadcopters. It has not been tested on other models. **NOTE: This protocol requires the addition of an ‘NRF24L01’ hardware module to function. See the following document for more information:**

http://www.deviationtx.com/wiki/#hardware_modifications

The H8_3D protocol supports 11 channels and only supports auto-binding.

The first four channels are Aileron, Elevator, Throttle and Rudder.

Channel 5 controls the LEDs.

Channel 6 controls Flip mode.

Channel 7 controls the still camera

Channel 8 controls the video camera.

Channel 9 controls headless mode.

Channel 10 controls RTH mode.

Channel 11 controls camera gimball on H11D and has 3 positions.

Both sticks bottom left starts accelerometer calibration on H8 3D, or headless calibration on H20.

Both sticks bottom right starts accelerometer calibration on H20 and H11D.

9.40 Protocol: *MJXq

The MJXq protocol supports the MJX quadcopters. It also has format options for Weilihua WLH08, EA-chine E010 and JJRC H26D / H26WH. **NOTE: This protocol requires the addition of an ‘NRF24L01’ hardware module to function. See the following document for more information:**

http://www.deviationtx.com/wiki/#hardware_modifications

The MJXq protocol supports 12 channels and only supports auto-binding.

The first four channels are Aileron, Elevator, Throttle and Rudder.

Channel 5 controls LEDs, or arm if H26WH format is selected.

Channel 6 controls Flip mode.

Channel 7 controls the still camera

Channel 8 controls the video camera.

Channel 9 controls headless mode.

Channel 10 controls RTH mode

Channel 11 controls autoflip (X600 & X800 formats) or camera pan

Channel 12 controls camera tilt

9.41 Protocol: *Bugs3Mini

The Bugs3Mini protocol is used to control MJX Bugs3 Mini and Bugs 3H aircraft. **NOTE: This protocol requires the addition of an ‘NRF24L01’ hardware module to function. See the following document for more information:**

To bind first choose the Bugs3Mini protocol and click Bind. Then apply power to the aircraft. The bind dialog will disappear if bind is successful.

Channels used for controlling functions. Set channel value greater than zero to activate.

- Arming is controlled by Channel 5
- Lights are controlled by Channel 6
- Flip is controlled by Channel 7
- Camera is controlled by Channel 8
- Video is controlled by Channel 9
- Angle/Acro mode is controlled by Channel 10 (>0 is Angle)

Telemetry is supported for RSSI and voltage alarm. It uses the Frsky telemetry display with signal strength reported in the RSSI field and battery voltage in VOLT1. The Bugs3 Mini receiver only reports good/warning/low voltage. This is translated to VOLT1 values of 8.40V for good, 7.10V for warning and 6.40V for low voltage.

9.42 Protocol: *E012

The E012 protocol is used to control the Eachine E012 quadcopter. **NOTE: This protocol requires the addition of an ‘NRF24L01’ hardware module to function. See the following document for more information:**

http://www.deviationtx.com/wiki/#hardware_modifications

The E012 protocol supports 10 channels and only supports auto-binding.

The first four channels are Aileron, Elevator, Throttle and Rudder.

- Flip is controlled by Channel 6
- Headless mode is controlled by Channel 9
- RTH mode is controlled by Channel 10

9.43 Protocol: *E015

The E015 protocol is used to control the Eachine E015 quad/car/boat. **NOTE: This protocol requires the addition of an ‘NRF24L01’ hardware module to function. See the following document for more information:**

http://www.deviationtx.com/wiki/#hardware_modifications

The E015 protocol supports 10 channels and only supports auto-binding.

The first four channels are Aileron, Elevator, Throttle and Rudder.

- Arming is controlled by Channel 5

- Led light is controlled by Channel 6
- Flip is controlled by Channel 7
- Headless mode is controlled by Channel 9
- RTH mode is controlled by Channel 10

9.44 Protocol: *NCC1701

The NCC1701 protocol is used to control the Air Hog Star Trek NCC-1701 quadcopter. **NOTE: This protocol requires the addition of an 'NRF24L01' hardware module to function. See the following document for more information:**

http://www.deviationtx.com/wiki/#hardware_modifications

The NCC1701 protocol supports 5 channels and only supports auto binding.

The first four channels are Aileron, Elevator, Throttle and Rudder.

- Warp is controlled by Channel 5

9.45 Protocol: *V911S

The V911S protocol is used to control the WL Toys V911-S helicopter. **NOTE: This protocol requires the addition of an 'NRF24L01' hardware module to function. See the following document for more information:**

http://www.deviationtx.com/wiki/#hardware_modifications

The V911S protocol supports 5 channels. The receiver must be bound manually one-time using the 'Bind' button, after which it should stay bound.

The first four channels are Aileron, Elevator, Throttle and Rudder.

- Calibration is controlled by Channel 5

9.46 Protocol: *GD00X

The GD00X protocol is used to control the C17 C-17 Transport and GD006 Diamond DA62 fixed wings. **NOTE: This protocol requires the addition of an 'NRF24L01' hardware module to function. See the following document for more information:**

http://www.deviationtx.com/wiki/#hardware_modifications

The GD00X protocol supports 5 channels and only supports auto binding.

The first four channels are Aileron, Elevator, Throttle and Rudder. Only throttle and aileron channels are used by the model.

- Lights are controlled by Channel 5

9.47 Protocol: *LOLI

The LOLI protocol is used to control popular DIY nRF24L01 receivers. **NOTE: This protocol requires the addition of an ‘NRF24L01’ hardware module to function. See the following document for more information:**

http://www.deviationtx.com/wiki/#hardware_modifications

The LOLI protocol supports 8 channels. The receiver must be bound manually one-time using the ‘Bind’ button, after which it should stay bound.

Receiver output modes are configurable via protocol options.

The first four channels are Aileron, Elevator, Throttle and Rudder.

Failsafe settings are supported.

Telemetry is supported.

9.48 Protocol: *E016H

The E016H protocol is used to control the Eachine E016H quadcopter. **NOTE: This protocol requires the addition of an ‘NRF24L01’ hardware module to function. See the following document for more information:**

http://www.deviationtx.com/wiki/#hardware_modifications

The E016H protocol supports 8 channels and only supports auto binding.

The first four channels are Aileron, Elevator, Throttle and Rudder.

- Flips are controlled by Channel 5
- Headless mode is controlled by Channel 6
- RTH mode (One Key Return) is controlled by Channel 7
- Emergency stop is controlled by Channel 8

9.49 Protocol: PPM

The PPM protocol is used to output PPM on the trainer port. It will disable all radio transmission. PPM is useful for connecting to simulators, or other radio-modules that plug into the trainer port. The Fixed ID has no effect, and there is no binding associated with this protocol.

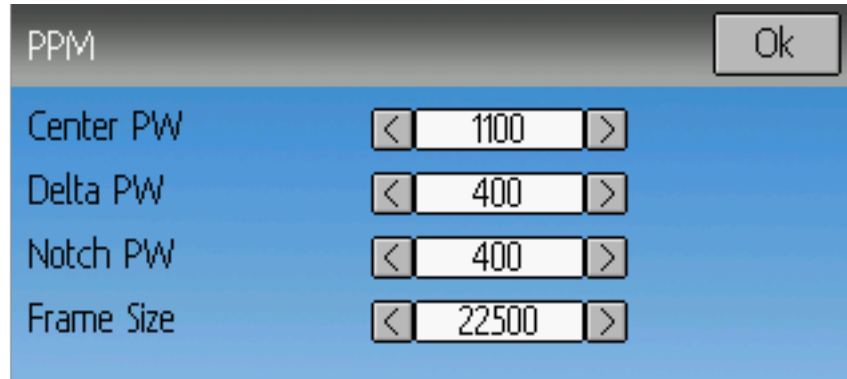

Options configurable on the PPM page:

- **Center PW:** Defines the time (in μsec) of the pulse that the transmitter transmits to represent to represent centered servo position. If this number doesn't match the master transmitter, the servos will not be centered.
- **Delta PW:** Defines the width of the pulse (measured from center) sent by the transmitter to define max servo throw. If this value is incorrect, the servos will not achieve full range (or will travel too much)
- **Notch PW:** Defines the delay between the channels.
- **Frame Size:** Defines the total time for all channels to be transferred.
- **Polarity:** Defines the polarity of the signal, Normal is active low.

Deviation does not auto-detect when a trainer cord is plugged into the transmitter. To use Deviation with a simulator (such as Phoenix), create a new model, name it appropriately, and select PPM as the protocol. Use the Re-Init button or power-cycle to enable PPM.

9.50 Protocol: USBHID

The USBHID protocol will convert the transmitter into a USB joystick. Connecting the transmitter to a PC via the USB cable will enable the transmitter to be detected as a joystick by the computer. This may be used to enable the transmitter to control any simulators that support joystick input. Some initial calibration may be necessary and is accomplished via the control panel applet of your operating system.

9.51 Protocol: SBUS

The SBUS protocol sends serial data on the transmitter's trainer port (tip connector). The trainer port ring is ground. On the T8SG PLUS transmitter the serial data also appears on the top pin in the JR module bay. The serial data is not inverted so an adapter may be needed for some SBUS equipment. Up to sixteen channels are supported. Data rate is 100kbps. Format is 8 data bits, even parity, two stop bits.

9.52 Protocol: CRSF (Crossfire)

The CRSF protocol sends Crossfire protocol serial data on the transmitter’s trainer port (tip connector). The trainer port ring is ground. On the T8SG PLUS transmitter the serial data also appears on the top pin in the JR module bay. To enable telemetry the serial input must be tied to serial output. For the trainer port tie tip to ring1. In the T8SG module bay tie the top and bottom pins together. Up to sixteen channels are supported.

The CRSF bind and configuration operations are not yet supported. Use a PC to bind the Crossfire module and receiver before using with Deviation.

Telemetry is not available on limited memory transmitters (7e, F4, F12).

Telemetry test page

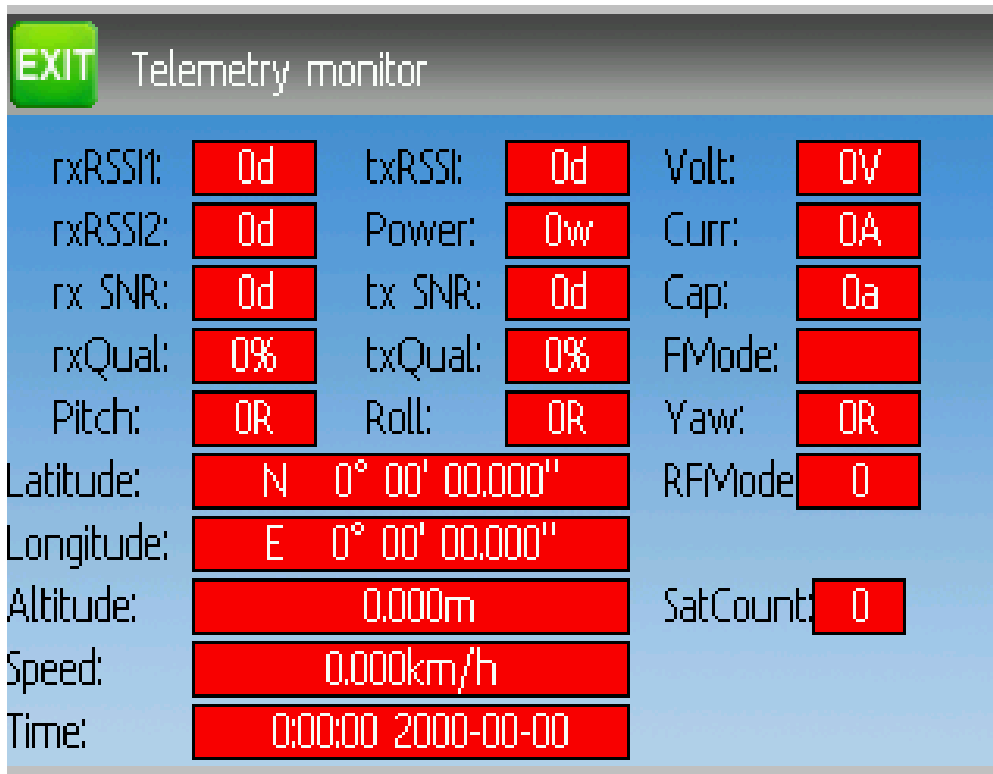

The CELL voltages are labeled C1-C5.

9.53 Protocol: PXX

The PXX protocol is an Frsky serial interface to their transmitter modules. Primarily useful for R9M and XJT modules in the JR bay of the T8SG Plus, but protocol is available on the serial port of other transmitters.

Up to 16 channels are supported. Telemetry (S.Port) is supported in the Frsky format for most transmitters. Due to memory constraints telemetry is not available in modular builds. Range check operation is supported. Module power setting is displayed as FCC/EU (e.g. 100/25mW).

Fixed ID is supported to link the transmitter with specific receivers. The Fixed ID corresponds to the receiver number in OpenTX to make sharing easier. Values 0 to 63 are valid. Fixed IDs above 63 are truncated to the valid range.

The following protocol options are available.

Failsafe: If the channel failsafe (in mixer channel config) is set this value is sent to the receiver every 9 seconds. The receiver will use these values in failsafe mode unless the protocol option is set to RX. For channels with failsafe set to off, the default Failsafe protocol option “Hold” commands the receiver to hold the last received channel values when the receiver enters failsafe mode. The “NoPulse” setting causes the receiver to not send any signal on PPM outputs (Testing on X8R showed SBUS values went to minimum, but SBUS behavior is not specified by the protocol). The “RX” setting prevents Deviation from sending failsafe settings so the receiver will use whatever failsafe values have been stored in the receiver.

Country: Set the country to match the firmware in the receiver. Options are US, JP, EU.

Rx PWM out: Choose whether PWM outputs of receiver are channels 1-8 or 9-16.

Rx Telem: Turn receiver telemetry on or off.

For transmitters without JR module the PXX signal is available on the serial port output. This is normally the trainer jack except for the Devo12. Use a stereo plug. Tip will be the PXX output, and ring is the s.port input. Sleeve is ground.

The T8SG V2 Plus requires a hardware modification to receive telemetry from a module in the JR bay. The trainer port ring must be connected to the bottom JR pin (see picture).

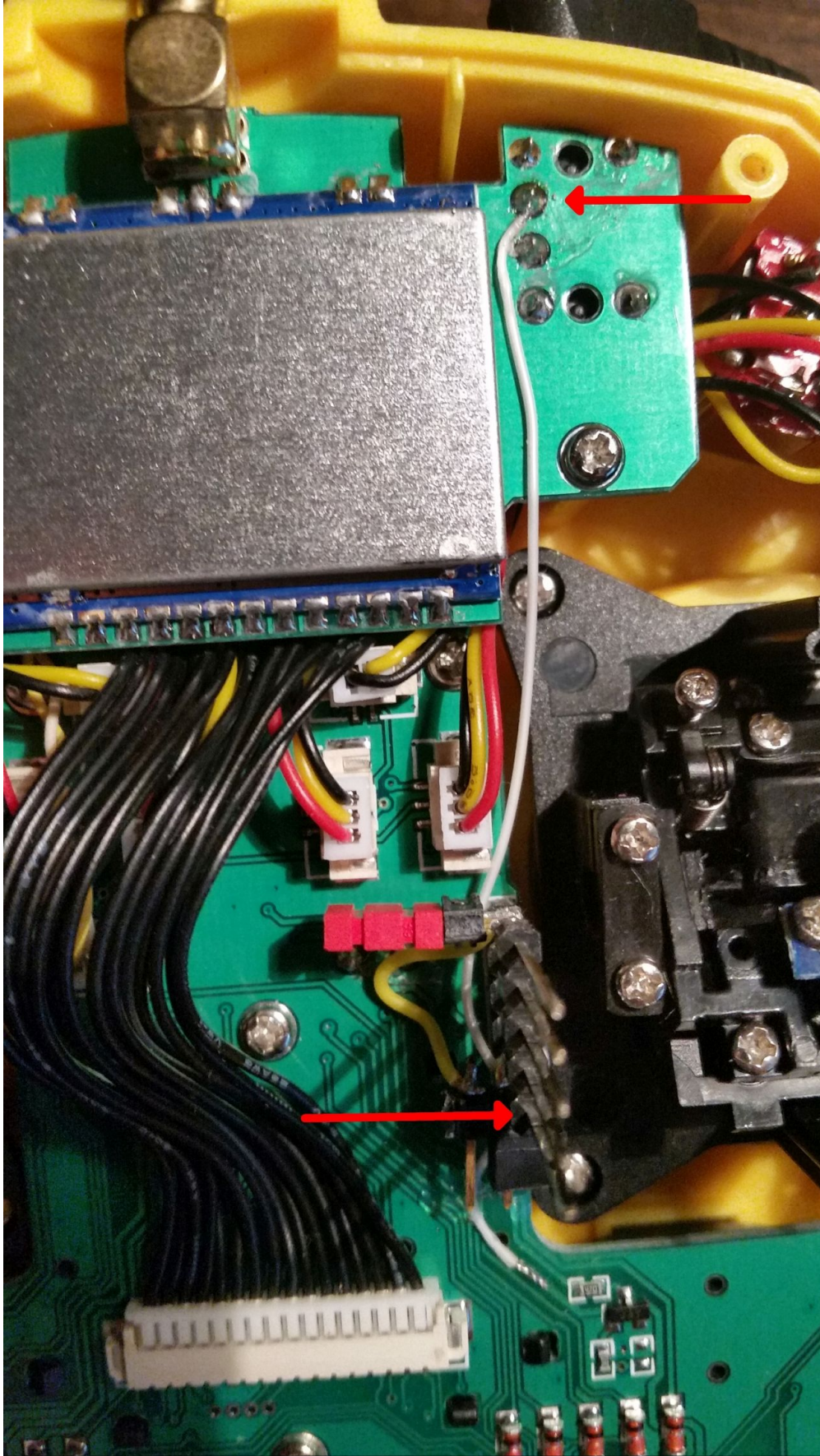

9.53. Protocol: PXX

10.1 Setting up a Buddy-Box

Deviation can be used to act as either the instructor (master) or student (slave) transmitter in a buddy-box configuration. In this mode, the instructor and student connect their respective transmitters together with a trainer cord via the DSC port. The instructor's transmitter will actually communicate with the model, but the instructor can use a switch to allow the student to control the model. When the switch is enabled, the student's transmitter sends input (stick) information through the trainer cord to the instructor's transmitter and these inputs replace the instructor's inputs.

Deviation can be configured to work with virtually any transmitter that supports either master or slave mode. Matching Deviation to a different manufacturer requires knowing the PPM parameters for the paired transmitter, and properly configuring the 'Center PW' and 'Delta PW' properly as well as knowing how many channels are transmitted and what the channel ordering is. The best place to find this information is to ask on the www.deviationtx.com forums.

10.1.1 Master Mode

Master mode is configured by selecting either 'Channel' or 'Stick' from the 'PPM In' spin-box in section *Model setup (Std & Adv GUI)*. Pressing 'ENT' on either 'Stick' or 'Channel' will show the 'Trainer Cfg' pages. The 2 modes behave slightly differently:

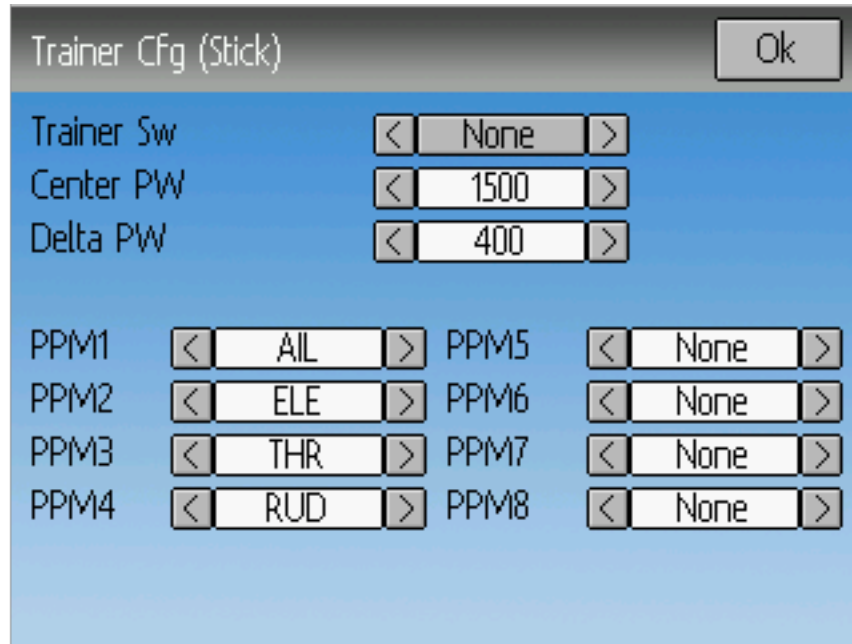

Stick: In stick mode, each input channel is mapped to a stick on the master transmitter. In this mode, the student moving the stick will behave exactly as if the instructor had moved the stick. Generally when using this mode, the student's transmitter will directly pass the stick position (no mixing) and the instructor's transmitter will do all necessary mixing.

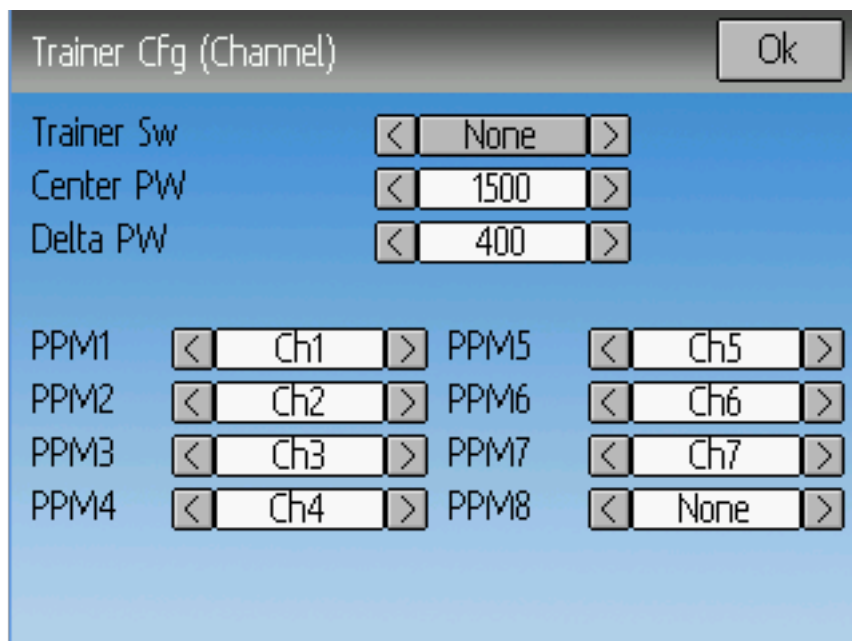

Channel: In channel mode, each input channel is mapped to an output channel on the instructor's transmitter. In this mode, the student's transmitter should do all necessary mixing to control the model. Care must be taken to ensure that the instructor and student transmitters are configured identically, otherwise, the model may not react well when switching between instructor and student control.

Options configurable on both Trainer Cfg pages:

- **Center PW:** Defines the time (in μsec) of the pulse that the student's transmitter transmits to represent centered servo position. If this number doesn't match the students transmitter, the servos will not be centered
- **Delta PW:** Defines the width of the pulse (measured from center) sent by the student's transmitter to define max servo throw. If this value is incorrect, the servos will not achieve full range (or will travel too much)
- **Trainer Sw:** Defines the switch that enables the student to take control of the model
- **PPM1...PPM8:** Defines the mapping (either channel or input) from the student's transmitter to the instructor's

10.1.2 Slave Mode

Slave mode is configured by choosing 'PPM' as the protocol in section *Model setup (Std & Adv GUI)*. Pressing 'ENT' on the Protocol spin-box will enable setting the output options. See section *Protocol: USBHID* for configuration. Note that Deviation will send the channel output data through the PPM. To use a Deviation slave transmitter with a Deviation Master configured for 'Stick' mode (see above), there should be no mixing done in the slave transmitter.

10.2 Setting Up FPV or Other External Inputs

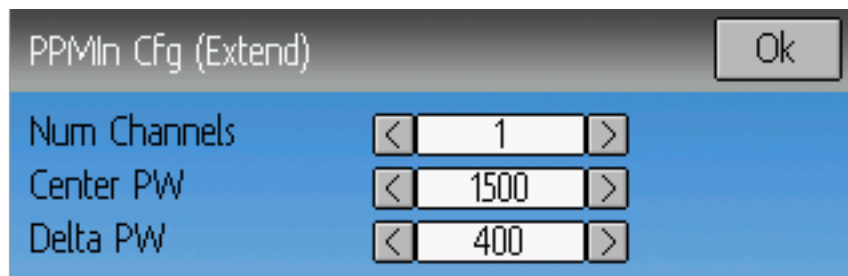

Deviation has the ability to use PPM input signals from an external source (such as an FPV setup). To configure this mode, set the PPM In mode to 'Extend' in section *Model setup (Std & Adv GUI)*.

Once enabled, press 'ENT' on the PPM In spin-box to configure the additional inputs.

Configuration options:

- **Center PW:** Defines the pulse-width for a centered input (in μsec).
- **Delta PW:** Defines the difference in pulse-width (from the center value) to reach min/max servo throw
- **Num Channels:** Defines the number of channels to input (generally no more than 8 can be supported)

10.3 Using a Trim as a Virtual Switch

Deviation has the capability to create virtual switches to supplement the mechanical switches of the transmitter. This capability is only available when using the Advanced GUI. There are 3 types of switches

available:

- **Momentary:** The switch will be active only as long as the trim button is held
- **Toggle:** The switch will toggle from on-to-off or off-to-on each time the trim button is pressed
- **On/Off:** The Trim+ button will turn the switch on, and the ‘Trim-‘ button will turn it off-to-on
- **3 Pos:** The switch will be active in one direction as long as the Trim+ button is held, and in the other direction as long as the Trim- button is held, returning to center when released.

To setup a virtual switch, start by selecting the trim from the ‘Trim’ page, and entering the trim-setup page. See *Trims and Virtual Inputs (Std & Adv GUI)*

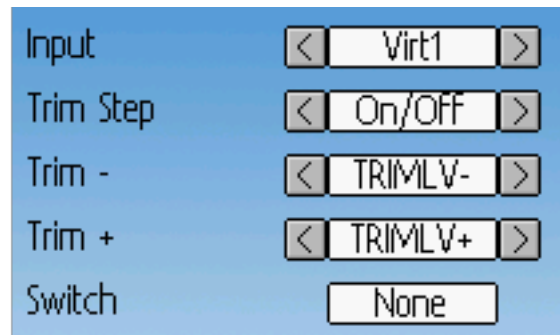

Next set the ‘Trim Step’ field to ‘Momentary’, ‘Toggle’, ‘On/Off’ or ‘3 Pos’. This is done by pressing the left-arrow on the ‘Trim Step’ spin-box until the value is less-than 0.1 Second select the ‘Input’ to be the virtual channel to convert to a switch (we’ll use ‘Virt1’)

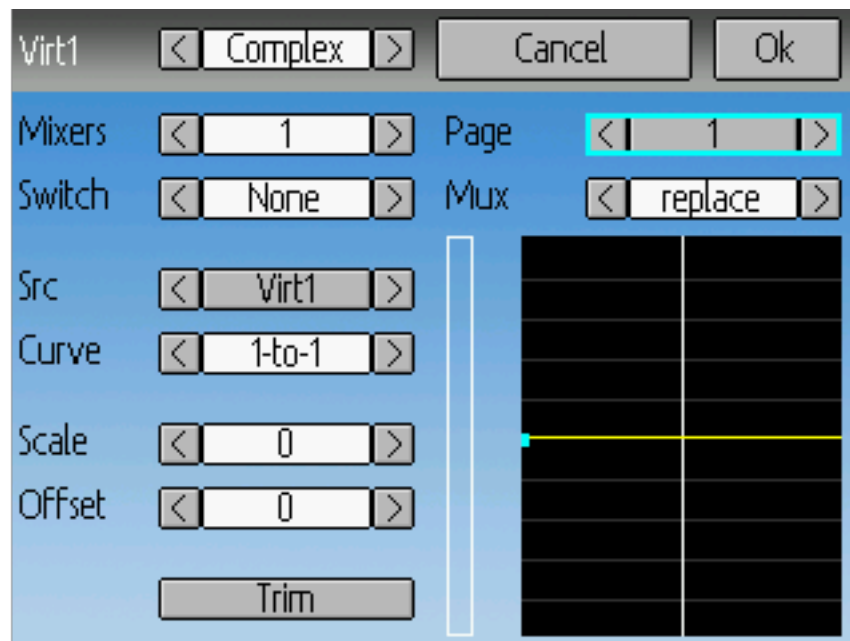

Now go to the ‘Mixer’ page, and enter the configuration for the specified Virtual Channel (Virt1 in our example)

Set the mixer-type to ‘Complex’, set the ‘src’ to the current virtual channel (‘Virt1’), set the curve to ‘1-to-1’ (Do NOT use ‘Fixed’), set the scale to ‘0’, and finally enable the ‘Trim’ button.

You can now use the virtual channel ('Virt1') like any other switch input. When the virtual switch is active, the virtual channel will have a value of 100, otherwise it will have a value of -100. In the case of '3 Pos', virtual channel will have a value of -100 when trim is pressed in one direction, +100 when pressed in the other direction, otherwise it will have a value of 0.

Note: If you use the virtual channel as a 'Src' (as opposed to a 'Switch') make sure that 'trim' is disabled for that mixer, otherwise the trim will be applied twice.

10.4 Swash Mixing

A swash-plate is used to control flight on an RC helicopter. The swash-plate controls the plane of rotation of the main-rotor as well as the blade pitch. A swash plate is normally connected to 3 servos known as Elevator, Aileron, and Collective, but due to its design, there is not a 1-to-1 correspondence between stick-movement and the servo movement. Instead some mixing is necessary between the throttle, elevator and aileron sticks and the swash-plate servos. This mixing is known as cyclic Collective Pitch Mixing (CCMP).

Traditionally, RC helicopters have used a flybar above or below the main rotor attached to a series of linkages to maintain stability. In these setups, the transmitter will normally do all of the mixing, and directly drive each of the 3 swash-plate servos. This configuration is known as manual-CCPM (mCCPM). Alternatively, an electronic mixer can be included on the helicopter either as part of the receiver, or between the receiver and servos, that can implement the proper mixing. This configuration is known as electronic CCPM (eCCPM) and in this case, the transmitter directly supplies aileron, elevator, and collective inputs, and the electronic mixer will convert the signals into appropriate swash-plate servo motion.

Recently, flybarless (FBL) helicopters have become more common, especially in the micro size range. These helicopters use an eCCPM system along with an electronic gyroscope to continuously adjust the swash-plate to maintain stability without the need for a physical flybar. This setup tends to be less expensive to manufacture, and also provides better stability and more precise control.

Deviation provides control for several swash-plate layouts, these include: 120°, 120° Alternate, 140°, 90°, and None. Each of these options are illustrated below:

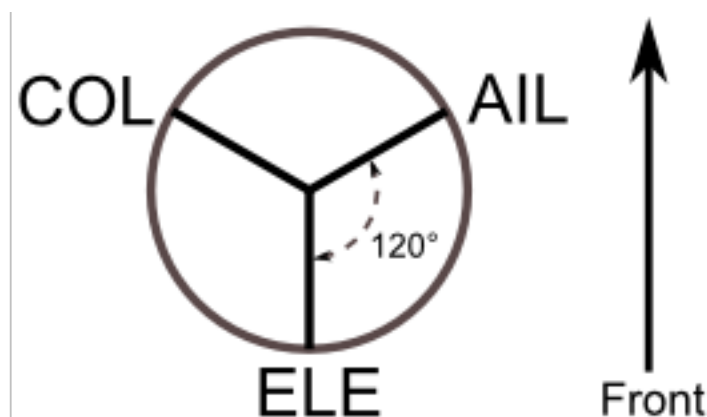

120 (3 Servo): Servos are placed around the swash-plate at 120° intervals. With Aileron input, the aileron and pitch servos tilt the swash-plate left and right; with Elevator input, the three servos tilt the swash-plate fore and aft; with Pitch input, all three servos raise the swash-plate up and down. Servos working in unison dramatically increases the torque available as well as the precision and centering.

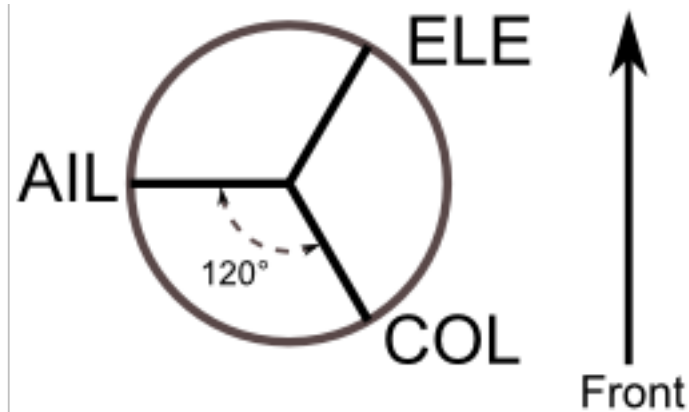

120X (3 Servo): Same as the above layout except servos are shifted 150°. With Aileron input, the three servos tilt the swash-plate left and right; with Elevator input, the elevator and pitch servos tilt the swash-plate fore and aft; with Pitch input, all three servos raise the swash-plate up and down.

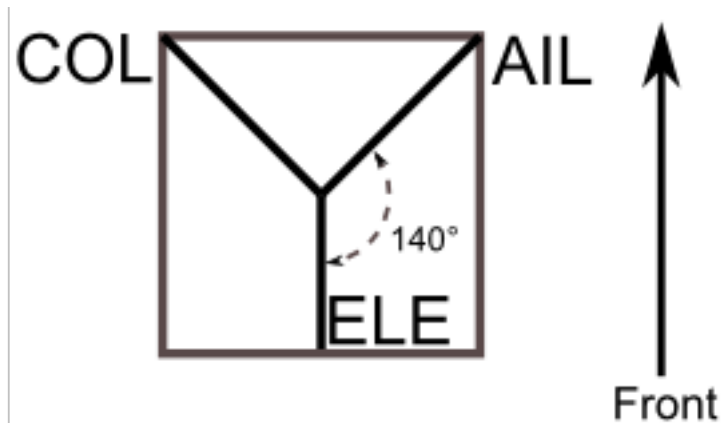

140 (3 Servo): Fundamentally, the servo operations of 140° swash-plates are almost the same as 120° swash-plates. However, the servo arrangement for elevator operation differs. 140° swash-plate CCPM offers smoother operation of the combined servos and an equal cyclic rate all around. On a 120° setup, the left/right cyclic is slightly faster than the fore/aft cyclic.

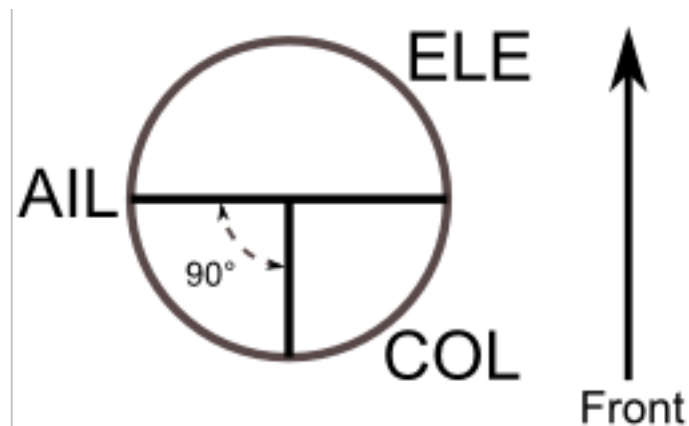

90 (3 Servo): With Aileron input, the aileron and pitch servos tilt the swash-plate left and right; with elevator input, the servos tilt the swash-plate fore and aft; with Pitch input, all three servos raise the swash-plate up and down. Most commonly used for electronic helicopters.

None: This is a special case where all mixing is done on-board the helicopter using a gyroscopic flight control system. Please refer to the specific manufacturers instructions to see how to configure mixer outputs.

Note: Some helicopters are 120 or 140, except rotated 180 degrees. In these cases you will still use the designated swash-plate type but may need to reverse specific channels.

10.5 Modifying sounds

You can edit the sounds your Devo makes, though you have to do it by mounting the transmitter as a USB drive and editing the 'sound.ini' file in the 'media' folder.

The sections, and what causes them to play, are:

- **startup:** Powered on.
- **shutdown:** Powering off.
- **volume:** Configuring transmitter volume.
- **timer_warning:** Timer is about to expire.
- **alarm#:** Timer # (1 to 4) has expired.
- **batt_alarm:** Battery low warning.
- **done_binding:** Binding finished.
- **key_pressing:** On a key press
- **saving:** When saving a model file.
- **max_len:** When you've exceeded the length of a string in the keyboard.
- **telem_alarm#:** Telemetry alarm # (1 to 6) has triggered.

In each section, you can adjust set 'volume' from 0 (off) to 100 (max). The rest of the entries are note names, and the value is the number of milliseconds to play that note. There is a limit of 100 notes for each sound.

The note names are 'xx', which is a rest (no sound played). You can then pick a note ('a'-'g'), possibly sharped by adding a 'x' if it's 'a', 'c', 'd', 'f' or 'g'. Finally, you can choose an octave with a single digit, ranging from '0' to '4'. Those take you from 'c0' (middle C) up to 'b4'. In addition, 'a', 'ax' and 'b' will play the three notes below middle C.

The emulator provides a way to test Deviation on your PC without uploading the firmware to your transmitter. It provides a visual display equivalent to that of the transmitter along with a side-screen displaying the current virtual-stick/switch states as well as the Channel output that would be received by the servos.

Download and unzip the deviation-emu_devoXX-vx.y.z.zip emulator package from:

<http://www.deviationtx.com/downloads-new/category/1-deviation-releases/>

where XX is the number of your Deviation transmitter. x.y.z identifies the deviation version number. Normally you should use the latest one. To start the emulator just run the exe file in the sub-directory.

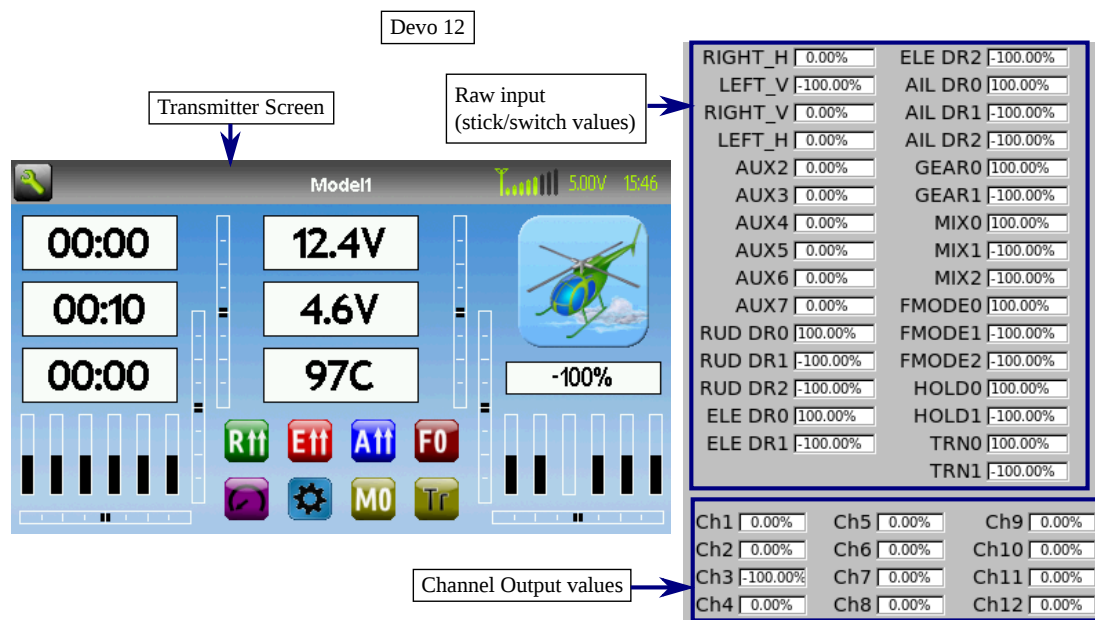

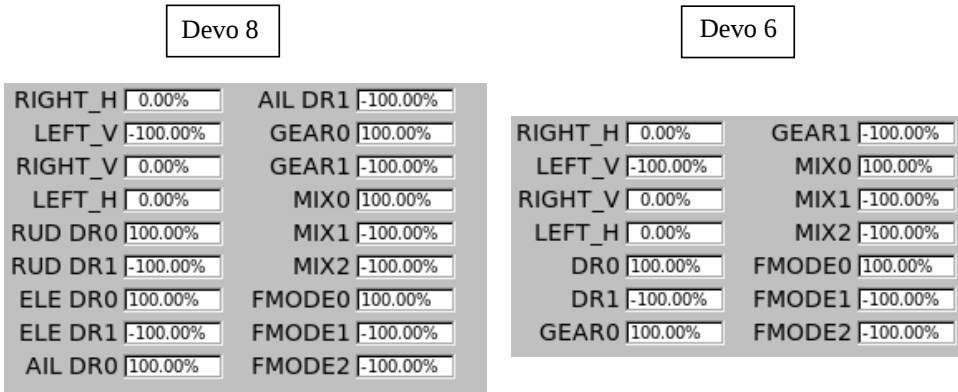

The emulator controls are as follows (based on an English QWERTY keyboard):

Keyboard	Function	Transmitter	
		12	8
q/a	Left-Vertical stick (Throttle in mode 2)	X	X
Q/A	Left-Vertical trim	X	X
w/s	Left-Horizontal stick (Rudder in mode 2)	X	X
W/S	Left-Horizontal trim	X	X
e/d	Right-Vertical stick (Elevator in mode 2)	X	X
E/D	Right-Vertical trim	X	X
r/f	Right-Horizontal stick (Aileron in mode 2)	X	X
R/F	Right-Horizontal trim	X	X
o/l	AUX2	X	
p/;	AUX3	X	
t/g	AUX4	X	
T/G	Top-Left trim	X	X
y/h	AUX5	X	
Y/H	Top-Right trim	X	X
u/j	AUX6	X	
i/k	AUX7	X	
z	Gear	X	X
x	Rudder Dual-Rate switch/SW B	X	X
c	Elevator Dual-Rate switch/SW A	X	X
v	Aileron Dual-Rate switch/	X	X
b	Mix 0/1/2 switch	X	X
n	FMode 0/1/2 switch	X	X
m	Hold switch	X	
,	Train switch	X	
\	Power off	X	X
Left-arrow	Left	X	X
Right-arrow	Right	X	X
Up-arrow	Up	X	X
Down-arrow	Down	X	X

Continued

Table 1 – continued from previous page

Keyboard	Function	Transmitter	
		12	8
Enter	Ent	X	X
Escape	Exit	X	X